

Product Catalog

Automotive and Automation Solutions

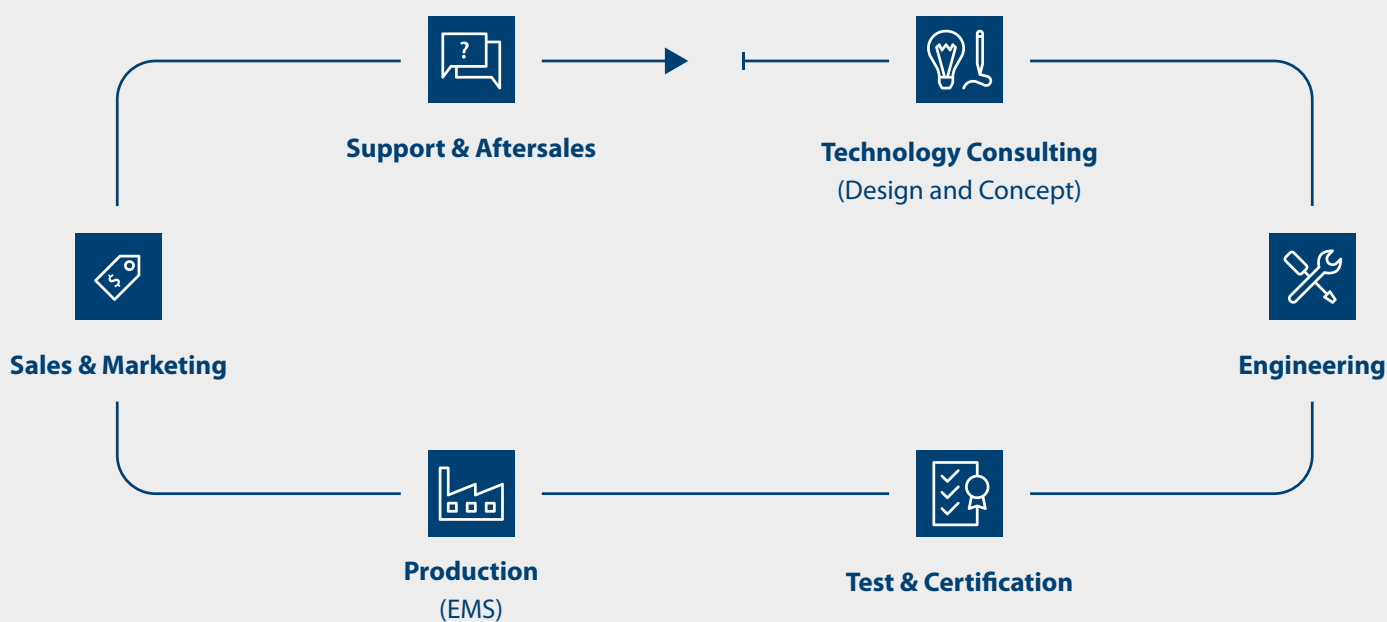



Sontheim – your system supplier for innovative electronics

As a specialist for fieldbus-based communication, control and diagnostic tasks, we are at your side as a reliable partner with our in-depth system know-how. Our modular hardware and software solutions enable optimal networking, automation and analysis of your automotive and industrial systems.

We cover the entire product life cycle, from the design and development phase through production to integration and support. The range of services includes individual prototypes, series deliveries up to customized solutions and complete technology, on-site consulting and training.

Our system solutions



Mobile Automation



Industrial Automation



Diagnostics



Connectivity

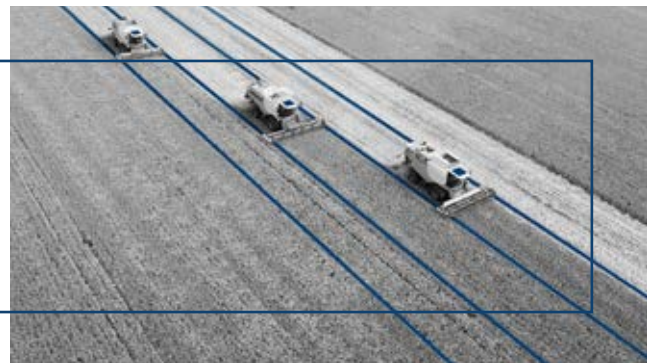

Our services

For 25 years, our customers worldwide have received a wide range of hardware and software components as well as automation and diagnostic technology services. Sontheim represents technically outstanding products, very close customer service and the combination of individual components to a complete solution that suits your needs. We offer both standardized and customer-specific products tailored to your individual requirements.

We apply our know-how in the area of fieldbus technology in various branches of the automation and automotive industry and thus cover a wide range of applications. Our focus is especially on CAN, EtherCAT, PROFIBUS and the protocols in the automotive sector. We support our customers worldwide, from the first idea and development phase to integration, support and beyond.



Technology Consulting – We bring your ideas to series

From the very beginning, we support you in your tasks and draw on our years of experience from many successfully implemented projects. Through our active participation in various standardization committees such as ASAM, CiA or the AEF, we have the most up-to-date knowledge of the latest standards and technologies. This expertise is always incorporated into our consulting services and guarantees state-of-the-art developments for our customers.

Engineering – As a system provider, we realize your ideas

As an expert in various fieldbus technologies, we support you with customer-specific developments. This covers the areas of software, hardware, firmware as well as design and conception of your automation or automotive solution.

Current topics such as efficient energy management, the optimal use of resources or solutions for Industry 4.0, drive us to develop innovative products and integrate them into your system.



Custom electronic systems and components

On our modern production lines we manufacture electronic components and systems according to your ideas in best quality, on schedule and of course cost-optimized. We are characterized by our flexibility and can assemble and manufacture batch sizes from just one prototype to series orders of almost 1,250,000 units per year. Our certifications confirm our constant focus on quality.

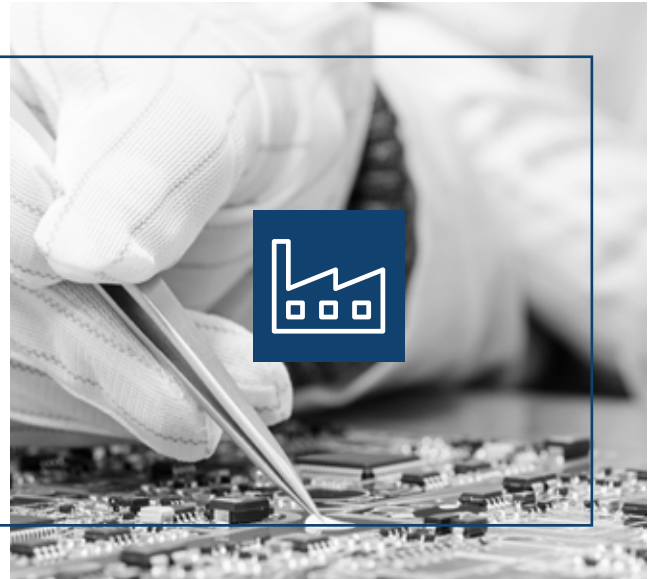

Obsolescence Management

With the help of our obsolescence management, we check and monitor the entire life cycle of your product. Often, semiconductors in particular have a shorter life cycle than the entire product and thus the production capability of electronic components depends to a large extent on these components. Our customers receive all relevant information over the complete product life cycle in order to be able to react at an early stage.



Workshops and Trainings

Are you looking for suitable training on CAN, current diagnostic applications and standards such as ODX and OTX, or detailed workshops on our products and services? We would be happy to impart the necessary knowledge in a workshop at our premises or at your site. Here we design the training courses individually and adapted to your needs and convey the contents in an understandable and user-oriented way.





Automotive

8



Mobile Automation	10
Controls	12
Displays	14
Sensors	16



Connectivity	50
Onboard Telemetry Modules	52
Smart Bluetooth Sensor	58
IoT Cloud Software	60



Diagnostics	18
Diagnostic Software	20
VCI's	28
Protocol Stacks	44
RAW CAN Analytics Tool	46
Breakout Box	49



Automation

66



Industrial Automation _____	68
Controls _____	70
IO Modules _____	84
Computer-on-Modules _____	118
Drive Technology _____	124
Printing Technology _____	128



Connectivity _____	140
Gateways _____	142
CAN Interfaces _____	144
CAN Interface Cards _____	152
IoT Cloud Software _____	156



Diagnostics _____	132
Diagnostic Software _____	134
RAW CAN Analytics Tool _____	136



Automotive



Mobile Automation



Diagnostics



Connectivity



We offer solutions for automation, diagnostics and connectivity of mobile machines. Our systems are future-proof, robust, scalable and based on the latest international standards. In addition to control units, display solutions and sensors, our portfolio includes innovative telemetry systems with associated cloud infrastructure for smooth analysis and evaluation of your vehicle data. We offer a seamless interaction of automation solutions, telemetry and standard-compliant diagnostics.

For more than 25 years, we have been supplying OEMs in the field of diagnostics with an integrated portfolio for the development and execution of complex diagnostic applications. Sontheim covers a wide range of development, service and maintenance applications, such as flash tools, end-of-line (EoL) programming and diagnostic software development. We are distinguished above all by our in-depth expertise with mobile machinery in the agricultural, construction machinery and specialty vehicle sectors as well as commercial vehicles.

Mobile Automation

Controls, Displays and Sensors















eSys-SVCx Product Family

Powerful electronic control units for safety-related applications up to ASIL-C. A rugged construction facilitate an optimal use in mobile machines.

Key Features

-  **Scalable safety controllers up to ASIL-C (acc. to ISO 26262)**
-  **High performance 32-bit Dual-Core Microcontroller**
-  **4× CAN interface acc. to ISO 11898**
-  **1× LIN**
-  **Up to 74 IOs**
-  **AUTOSAR compliant**
-  **Robust aluminium housing with automotive connectors**
-  **Certificated acc. to ECE R10 (eSys-SVC3 xt)**

eSys-SVCx product family

The Safety ECU family consists of two different high-end safety modules with different configuration options. The wide range of applications offers numerous possibilities for use in mobile machines such as trucks and trailers, as well as construction, agricultural and special-purpose machines.

Interfaces and safety-certified up to ASIL-C

A powerful 32-bit dual-core microcontroller with 160 MHz, up to four CAN, one LIN interface and 74 IOs (including PWM current control) can be used for applications up to Automotive Safety Integrity Level C (ASIL-C). The risk classification is defined by the ISO standard 26262 for safety-relevant electrical/electronic systems in motor vehicles. The electronics are protected by a robust die-cast aluminium housing and robust automotive connectors facilitate the connection to the control unit.

AUTOSAR-compliant software

The safety controllers are available with various software packages. Starting with QM (quality management) based software up to ASIL-C and AUTOSAR compliant software, you can choose which software architecture is required for your application. This flexibility allows you to use it for

a wide range of applications and safety requirements. It always provides the customer with the optimum Safety-ECU – optimized for the individual application and the best possible cost-benefit ratio.

The AUTOSAR standard

AUTOSAR is an open and standardized software architecture for automotive ECUs (without infotainment). The architecture scales to different vehicle and platform variants, takes into account system availability and system safety requirements, and supports software transferability, sustainable use of natural resources, and ease of maintenance throughout the entire product life cycle.

Among other things you benefit from:

- Reduction of the number of ECUs in the vehicle by flexible assignment of ECU data with multiple functions
- Easier integration into the vehicle through a defined architecture
- Reusability of functions through fixed standards for important system functions and interfaces
- Easy scalability and expandability. This makes a functional development for smaller quantities interesting
- Function development possible, independent of the existing topology in specific vehicles

Technical Data

CPU	eSys-SVC3 xt	eSys-SVC4 xt
CPU	32-Bit microcontroller dual-core, 160 MHz	
RAM	128 KB internal	
Memory	1 MB internal	

Interfaces & Inputs/Outputs	eSys-SVC3 xt	eSys-SVC4 xt
CAN	3x CAN interface accord. to ISO 11898 & CAN 2.0 B	4x CAN interface accord. to ISO 11898 & CAN 2.0 B
LIN	1x (optional)	1x
Analog inputs, Pulldown 0–5 V and 0–32 V	9x (6x SAFE); 0–5 V and 0–32 V	20x (14x SAFE); 0–5 V and 0–32 V
Digital inputs or RPM inputs	2x (1x SAFE)	16x (1x SAFE)
Pulse inputs	2x	6x
PWM/HSS/LSS outputs	5x PWM (5x SAFE) current range 0 to 2.0 A 4x HSS current range 0 to 2.0 A 2x LSS current range 0 to 1.0 A	15x PWM current range 0 to 2.0 A 10x HSS current range 0 to 2.0 A 4x LSS current range 0 to 1.0 A
Fixed voltage output	2x 5 V, stabilized supply voltage, short-circuit proof	
Sensor voltage output	1x 12.7 V (optional)	1x 12.7 V
3D acceleration sensor	1x (optional)	1x

Housing	eSys-SVC3 xt	eSys-SVC4 xt
Plug	154-pin connector	
Housing	IP68 (opt. IP6K9K), die-cast aluminium	
Dimensions	approx. 170 mm × 214 mm × 34 mm	approx. 229 mm × 228 mm × 34 mm
Operating temperature	–40 °C up to +85 °C housing temperature	
Storage temperature	–40 °C up to +90 °C housing temperature	

Supply Voltage	eSys-SVC3 xt	eSys-SVC4 xt
Supply voltage	8–32 V (12 V or 24 V Board Version)	
Power consumption	Quiescent current approx. ca. 2.9 mA at 28.5 V, total current up to 41 A	Quiescent current approx. ca. 3 mA at 28.5 V, total current up to 80 A



CAN Display

Robust display for mobile machines, commercial vehicles and engine applications. Visualization, monitoring and control of all commands and status information via CAN.

Key Features



High resolution terminal



5" TFT 16:9 display



5 LED illuminated buttons



1× CAN interface acc. to ISO 11898



Linux operating system



Ready for MDT® 2.0 applications

The display has a 5 inch TFT 16:9 display and convinces with a high resolution and with 800–1000 cd/m² a extremely good readability, even in poor lighting conditions. Via CAN according to ISO 11898 and with J1939 protocol support, status information such as alarm messages can be displayed or a specific diagnostic evaluation can be made. The operation is simple and clearly arranged by means of five illuminated buttons

Own customer applications can be implemented using the MDT® 2.0 authoring system. This allows an individual design and unique graphical user interfaces, while adhering to the common diagnostic standards ODX acc. to ISO 22901-1 and OTX acc. to ISO 13209. Thus, the manufacturer is not only able to design his user interfaces and processes on the display, but at the same time to set up the display as an analysis instrument in consideration of diagnostic standards. Embedded diagnostics of your systems is thus possible.

Technical Data

	CAN Display	CAN Display xt
CPU	Freescale i.MX6 dual core	
RAM	512 MB DDR2	
Memory	4 GB eMMC	
Display	5" TFT 16:9, 16 million colors, antiglare	
Resolution	800×480 WVGA, 24-bit color	
Backlighting	1000 cd/m ² (50.000 h lifetime)	
CAN	1x CAN acc. to ISO 11898 Standard, 50 Kbit/s up to 1000 Kbit/s (250 Kbit/s default value)	1x CAN acc. to ISO 11898 Standard, 50 Kbit/s up to 1000 Kbit/s (250 Kbit/s default value) 1x galv. isolated CAN acc. to ISO 11898 Standard, 50 Kbit/s up to 1000 Kbit/s (250 Kbit/s default value)
Bluetooth	–	optional
Further protocols	J1939, proprietary protocols	
Buzzer	integrated 75 dBA	
IOs	1x DO 500 mA (LSS)	1x DO 500 mA (LSS), 1x DI, 2x AI
Buttons	5x, static illuminated	
Operating system	Linux	
IP Classification	IP65	
Housing	Plastic Housing PC-ABS	
Dimensions (l×w×h)	108 mm × 139 mm × 45 mm	
Weight	app. 220 g	
Operating temperature	–30 °C up to +70 °C	
Storage temperature	–40 °C up to +85 °C	
Input voltage	6 V up to 32 V DC	



End-to-end diagnostic system solutions

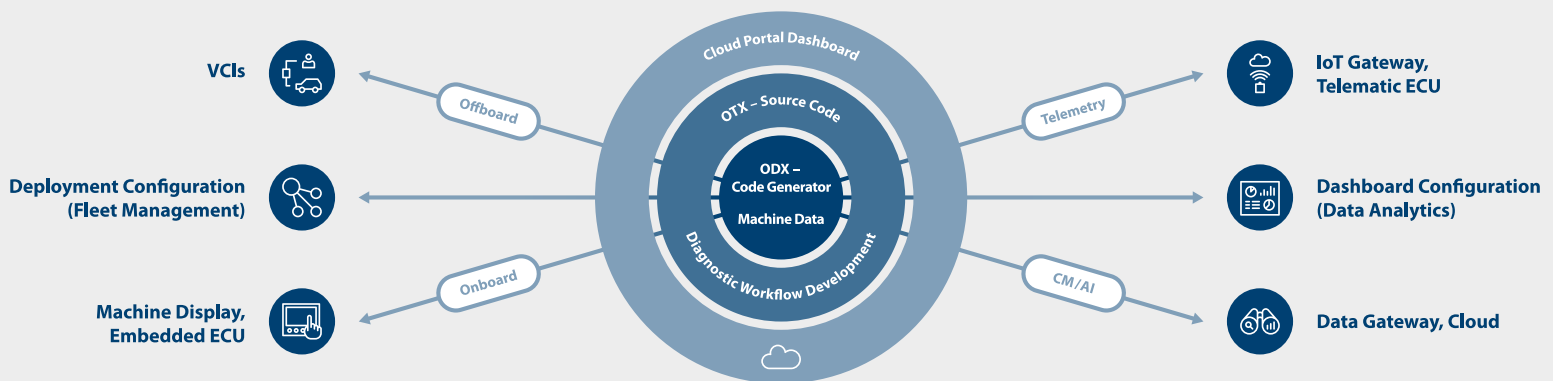

Order information







V966370400	CAN Display 5"
V966370410	CAN Display 5" xt



Ultrasonic Wind Sensor

With CAN interface and J1939 protocol support

Key Features

-  **1× CAN acc. to ISO11898**
-  **J1939 Protocol-Support**
-  **IP69K Protection class**
-  **Windspeed from 0–50 meter/s**
-  **360° wind direction**
-  **Measurement of temperature and humidity**
-  **No moving parts**

The ultrasonic wind sensor convinces by an extremely compact and robust construction. The sensor has no moving parts and therefore no mechanical wear. All environmental data are measured and provided by ultrasonic technology. The data can be transmitted easily and quickly via a CAN interface and J1939 protocol support.

The sensor convinces with extremely fast data handling and can acquire up to 50 measurements per second. Wind speeds of 0–50 meters per second can be recorded. Further measurement data are wind direction, temperature and humidity. To prevent the sensor from freezing in sub-zero temperatures, the device also has an integrated heating system.

Technical Data

CAN	1× CAN acc. to ISO 11898 standard
Further protocols	J1939
IP classification	IP69K
Wind directions	0–360°
Wind speed	0–50 m/s
Wind temperature	–40°C up to +70°C
Humidity	20 % – 80 %, temporarily 0 % – 100 %
Air pressure	300 hPa – 1200 hPa
Heating	Yes
Dimensions	100 mm × 133 mm × 71 mm



Position sensor

2-axis CAN sensor for measuring tilt acceleration

Key Features

CAN

1× CAN interface acc. to ISO 11898

J1939

J1939 protocol support



Robust plastic housing acc. to IP67/IP69K



12 V DC power supply

CAN sensor for the measurement of inclination accelerations with two axes. Communication is via CAN according to ISO 11898, J1939, CANopen or also via RAW CAN.

A robust plastic housing to IP67/IP69K provides the necessary protection for the electronics.

Technical Data

CAN	1× CAN interface acc. to ISO 11898
Further Protocols	J1939
IP Classification	IP67 or IP69K
Acceleration	±3.5 g
Air pressure	up to 115 kPa
Temperature	−20°C up to +85°C

Diagnostics

Software, VCIs, Protocol Stacks





Sontheim

Sontheim

COMfalcon plus
Communication Interface Generation 2









K-Line COM On



MDT® 2.0

The Modular Diagnostics Tool 2.0 offers you next to ODX and OTX standard also a MCD-3D server, simple and modern operation in Visual Studio® and multi-platform compatibility with only one workflow creation

Key Features

-  **ODX acc. to ISO 22901-1**
-  **OTX acc. to ISO 13209**
-  **Multi platform support**
-  **High-performance runtime system**
-  **MCD-3D Server**
-  **ODX and OTX Editor**
-  **Supported standards: CANopen, SAE J2534, SAE J1939, ISO 15765 (KWP2000 on CAN), UDS, DoIP, ...**
-  **RMI native**
-  **Direct Microsoft Project integration**

Future proven diagnostic tool chain – based on standards

The new MDT® 2.0 offers a standardized way to access diagnostic data. The MDT® 2.0 tools offer various possibilities to create, structure and run diagnostic workflows using the industry standard OTX (Open Test sequence Exchange format) defined in ISO 13209. Re-use of your diagnostic service descriptions in ODX (Open Diagnostic Data Exchange) for service execution allows you to instantly achieve your desired results. On top of that MDT® 2.0 supports native RMI as well as an innovative OTX wizard (Sontheim OTX diagnostic wizard) to simplify OTX editing without breaking the ISO standard.

Multi-platform support – one workflow for all applications

The Runtime was developed especially for multi-platform capabilities and offers GUI support as well as a platform-independent description of the runtime workflow language generated from your OTX and ODX files. This reduces implementation and testing effort for your diagnostic applications across multiple PC and embedded platforms. MDT® 2.0 allows you to develop your application once and have it running on Windows, Linux x86, Linux ARM, QNX and others.

The optimized runtime and the MCD-3D light server have been developed and optimized especially for embedded diagnostic applications. Thanks to the extremely slim runtime system, the diagnostic application can run directly embedded in the vehicle (for example on the terminal or a telemetry unit), which offers the user of the diagnostic application completely new diagnostic options.

Modern design and graphical modules

The MDT® 2.0 Authoring Tool is based on Visual Studio in order to fulfill the needs of modern developers. A new, clear and modern design allows usage of Visual Studio Plug-Ins for SVN, Git and other development extensions

commonly used. In addition, new graphic elements like 2D and 3D animations can be used to make your diagnostic application more visually appealing and lower the learning curve for your service staff and diagnostic application users.

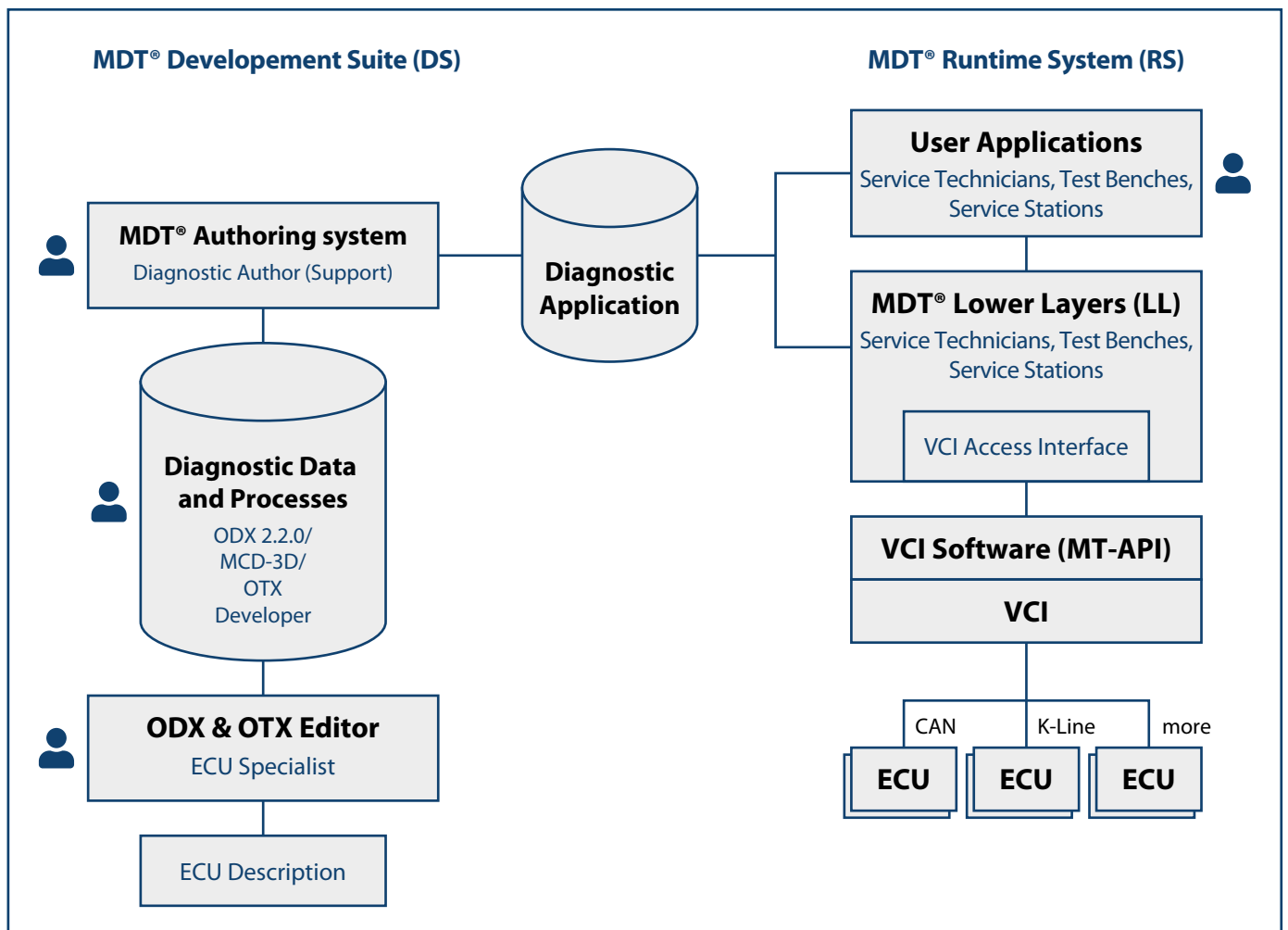
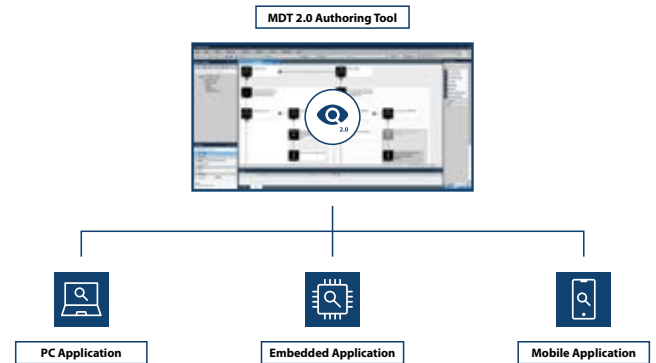

Order information

V940800300	MDT® 2.0 Authoring system
C940800300	MDT® 2.0 Authoring system maintenance



MDT[®] Service Cloud

The MDT[®] Service Cloud enables a comfortable monitoring and maintenance of diagnostic data. Updates of the diagnostic application can be downloaded and installed via update tool worldwide. Moreover data can also be exchanged and analyzed specifically out of the diagnostic application.

Key Features



Easy data exchange of your diagnostic application (Up- and Downloads)



Administration of session logs, vehicle file information, HEX files, reports, etc.



Server hosting included



High data security through HTTPS logging and SSL/TLS encryption



Direct connection to an ERP system

Fast data exchange and update tool

The MDT[®] Service Cloud enables an interactive data exchange of your diagnostic application at any time and from any location. It was implemented for an easier and more effective diagnostic analysis in the Modular Diagnostic Tool (MDT[®]). An update tool enables updates of the diagnostic application which can be downloaded and installed. In addition, out of the diagnostic application itself, data can specifically be up- or downloaded. Thus, for example, session logs, vehicle record information, reports, HEX files, etc. can be loaded or saved in the cloud. The transmitted data formats and contents are freely definable.

Automated interface for ERP system

The MDT[®] Service Cloud is a prefabricated system and can be linked directly with the internal ERP system of your company and be adapted and integrated to the requirements of the customer. Thus the required maintenance is significantly reduced and all data exchange and updates can be managed directly from the ERP system. This relieves the administrative burden and allows, among other things a centralized license management and automated processes. Furthermore, the administration of the diagnostic information can also be done manually using an FTP server.

Server hosting for local and in-house infrastructure

Sontheim offers a server hosting, thus there is no additional effort for the user of MDT® Service Cloud. This infrastructure can also be used locally or internally to exchange and manage for example data of test rigs or end of line programming.

High data security through HTTPS and SSL/TLS encryption

The safe way to the Internet can lead only through a secured and authenticated connection. Therefore HTTPS logging and encrypted data transfer using a SSL/TLS certificate are used for the MDT® Service Cloud. Using the digital certificate the reliability of the server and the con-

nection is ensured. In addition to the encryption also an authentication (user and password) of the client excludes an access by third parties.

Schematic overview of the MDT® Service Cloud

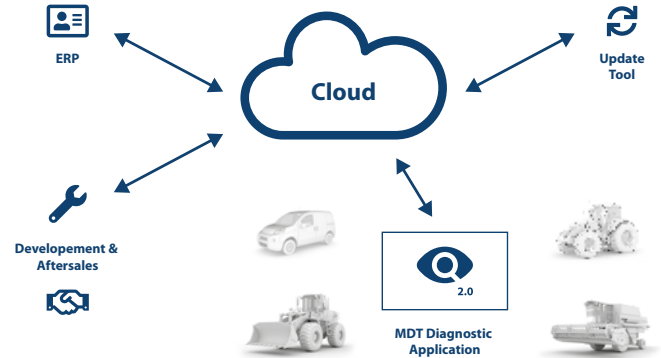

MDT® toolchain overview



MDT® Authoring System SIE Setup Tool
MDT® Service Cloud



CLC Manager ODX-Editor



CANexplorer 4

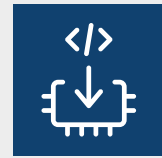

Flash-Tools End-of-Line (EOL)



Protocol stacks



ECU flash- and bootloader

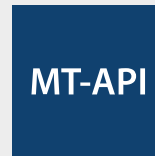

Multithread API



VCIs/CAN Interfaces

Order information

V940810010	MDT® Cloud SIE Server
V940810020	MDT® Cloud Customer Server
V940810030	MDT® Cloud License

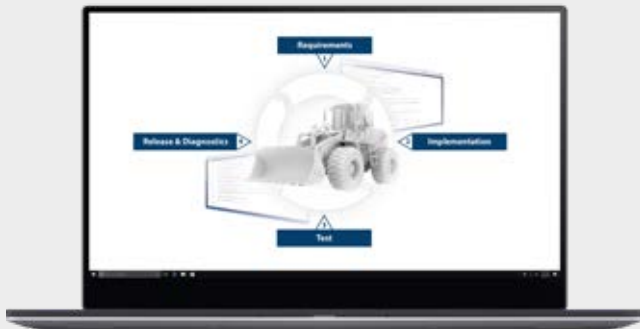

Communication Lifecycle Manager 2.0

Key Features



Web-based tool



Management of all fieldbus-based data from specification to release



Development, mapping and maintenance of the communication interfaces of ECUs



Description of the entire data flow between ECUs and in the ECU itself



Simple linking with the Sontheim MDT®



ODX 2.2.0 Support

The Communication Lifecycle Manager 2.0

The CLCM 2.0 of the Sontheim Industrie Elektronik GmbH is a centralized system for managing and authoring the diagnostic and communication description of ECUs and complete vehicles. It is a client-server-based web application that allows several users to work collaboratively on the same project. There is no client installation necessary and the server can be accessed from different platforms via browser.

The CLCM 2.0 can be integrated in the existing infrastructure and development workflow. It is intended to accompany the whole development process of ECUs or vehicle:

All advantages at a glance:

- Beginning with a high-level overall vehicle structure during the requirements phase
- More refined specification of the ECUs during implementation phase
- Validation of the described network during testing phase
- Provision of generated source code, documentation and diagnostic description after the release

Editing Views

ODX Explorer

The CLCM 2.0 features an ODX Explorer that allows the navigation through the hierarchical structure of an ODX file and provides form-based editors for the elements. For example, this view allows users with advanced ODX knowledge to define the overall structure of an ODX file and also to make specific changes to certain elements. The view provides usability features like reference handling, search and copy&paste.

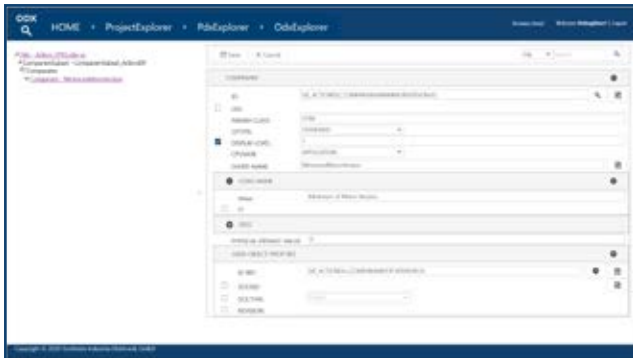

Grid View

The CLCM 2.0 features a Grid View that allows a generic and protocol specific representation of commonly used data structures, e.g.: DIAG-SERVICES, TABLES, DTCS and ENV-DATAS. For example, this view allows an ECU developer to define multiple diagnostic services that have the same fundamental structure and only have different identifiers and payload data. The underlying complex ODX structures are hidden and displayed in a simplified way to only show the relevant information necessary to accomplish this task. The Grid View has wide-scaled customization possibilities to incorporate company specific guidelines for the diagnostic description.

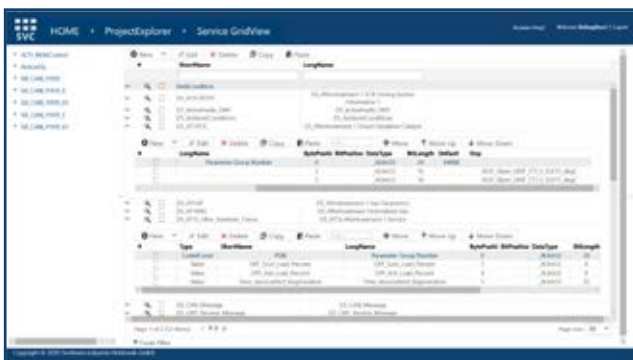

Vehicle View

The CLCM 2.0 features a Vehicle View for the high-level management of different vehicle types of a company. For each vehicle model the bus and the connected ECUs can be represented to give an overview of communication within the vehicle network. It allows the assignment of software packages and the released software version for the ECUs.



Test View

The CLCM 2.0 features a Test View that allows to verify the defined diagnostic services against the actual ECU or simulation. Services are configured and executed using MDT® 2.0. It is a D-PDU API based runtime system. The connection with the ECU is realized either with:

- A locally connected VCI via USB (e.g. SiE MT-API) or
- An ethernet based VCI via LAN/WLAN (e.g. using J2534)

Code Generator

The CLCM 2.0 features a customizable code generation mechanism that can be used to create source code and documentation that is based on the diagnostic data. The output is fully customizable and can be used by different platforms and programming languages. This allows the integration in existing software modules and libraries.

Possible uses cases are:

- Source code for ECU software, diagnostic application and testing environments
- Documentation for development, production and service department

The code generation mechanism can be integrated in the customer specific build infrastructure.



Script



Source code

Extension API

The CLCM 2.0 features an Extension API that allows to modify the default views and also allows the creation of new customer specific views. Extensions are written in a .NET programming language (e.g. C#) and have access to the complete diagnostic data of the projects.

User Management

- Access to data and files can be restricted for specific user groups and individual users
- Features can be enabled/disabled for specific user groups and individual users
- Supports authentication via Active Directory

Technical Data

Server Requirements (Minimum)

Windows Server 2016; IIS 10.0; SQL Server 2016;
CPU: 4 Cores; RAM: 6 GB; Storage: 75 GB

Client Requirements (Minimum)

Web Browser (Chrome, Firefox, Edge)

Order information

V940830100

CLC Manager 2.0

C940830100











CLC Manager 2.0 Software Maintenance



COMfalcon® IoT

The new high-end VCI with Linux operating system and IoT functionality thanks to mobile data transmission.

Key Features

-  **4x independent CAN interfaces**
-  **LTE/2G**
-  **WLAN interface**
-  **LAN interface**
-  **Bluetooth optional**
-  **BroadR-Reach optional**
-  **Data logging, scripting, CAN**
-  **GNSS optional**
-  **Housing with integrated bumper**
-  **Protection class IP44**

The Vehicle Communication Interface – new standards in the service sector

COMfalcon® IoT combines the robustness of our proven interfaces with the latest interfaces and features. Thanks to modern LTE (2G fallback) communication, you can transmit data at any time and from anywhere. Remote diagnostics or even flash-over-the-air applications, such as on an integrated on-board telemetry are thus possible at any time, even in the handheld area. Other wireless interfaces include WLAN and Bluetooth 5.0 LE to establish a connection to a diagnostic device. In addition, the device also has a LAN interface and a BroadR-Reach interface for broadband data exchange. The VCI can be connected to a vehicle via four independent CAN (CAN FD ready) channels.

Housing and status indicators

The COMfalcon® IoT has a IP44 housing with bumper as well as extremely stable heavy-duty connectors. A software configurable trigger function for easy and individual data recording is also integrated. Thanks to its compact design and high shock resistance, COMfalcon® IoT can be used in various areas of the automotive industry. Two multicolor LED bars and an LED status display always visualize the current status/error code of the device.

Technical Data

CPU	32-bit microcontroller, Cortex-A9 (dual core)
RAM	512 MB DDR3
Memory	Up to 64 GB
CAN	4× galvanically isolated CAN interfaces acc. to ISO 11898 (CAN FD capable)
Baud rates	50 Kbit/s up to 5 Mbit/s
CAN Port	4× on 25-pol. D-Sub
BroadR-Reach	1× on 25-pol. D-Sub
LAN	M12 4-pin female connector 10/100 Mbit LAN
WLAN	1× acc. to IEEE 802.11b, g, n (internal antenna)
Bluetooth	1× optional 2.1+EDR, Power Class 1.5, BLE 4.0 and ANT
Mobile communications	LTE
LEDs	LAN status LED (green and yellow) WLAN/Bluetooth status LED (green and yellow) 4× CAN atatus LED (green and yellow)
Dimensions (l×w×h)	110 mm × 150 mm × 35 mm
Housing	Synthetic material, protection class IP44
Operating temperature	−40 °C up to +60 °C
Storage temperature	−40 °C up to +85 °C
Supply	via D-Sub 12 V – 24 V via round pole 12 V stabilised



Customized cable harnesses

In addition to standard cable sets, customer-specific cable sets can be provided at any time. A 25 pin connector allows the VCI to connect to a vehicle via the customized or standardized (OBD/ISO) interface.

Embedded diagnostics

Own embedded applications can be operated directly on the COMfalcon® IoT. This makes the connection to a third device (laptop or PC) obsolete. Information, such as flash routines or ECU descriptions, can thus be created and implemented on the VCI. This enables users to access the CAN or file system, for example. OTX workflows and ODX descriptions thus work out-of-the-box with the new COMfalcon® IoT. This allows applications to be rethought. Diagnostic applications can be implemented holistically on the VCI, with any LAN/WLAN-capable end device (WIN/MAC/Android) taking over the display. The embedded applications are portable and reusable for future Sontheim VCI generations.

Controller and operating system

A powerful dual core controller, 500 MB of RAM and the integrated Linux operating system ensure maximum performance and flexibility. Data up to 64 GB can be stored on the integrated memory.

Further functionalities

In addition, GNSS integration is available for the Vehicle Communication Interface. The current location is recorded and transmitted worldwide. In addition, the IoT Device Manager provides the appropriate cloud software. Whether updates-over-the-air or fleet management – the portal offers OEMs all the possibilities of a state-of-the-art analysis of all devices in the field.

Order information

V930232600

COMfalcon® IoT



COMfalcon®

COMfalcon® is a powerful VCI with WLAN/LAN interface and various equipment options. Use it for monitoring, flashing or analyzing CAN networks and handling layer-7 protocols like CANopen or SAE J1939. It is a very flexible and easy to use tool for the detection of CAN data and monitoring of entire networks.

Key Features

- CAN
4× independent CAN channels
- WLAN
WLAN interface
- ✓

RS 232
 RS 422
 RS 485
- K-Line
K-Line
- ☑
Protocol handling
- 📄
Optional with data logging, scripting, CAN voltage level oscilloscope functionality
- SD
Optional with integrated SD card
- IP
Compact housing with protection class IP65

Housing and status indicators

The device has a fairly rugged housing built of aluminium with IP65 protection. Thanks to the compact design and high shock resistance, COMfalcon® can be used for various automotive applications. Two 14-segment displays and nine LEDs are always showing the current status/error code of the device.

Interfaces

The COMfalcon® has four independent CAN channels and is based on the CAN interface CIN with a Freescale PowerPC architecture. WLAN/LAN (infrastructure mode) is used to connect to a diagnostic laptop/PC. In addition to the CAN interfaces a various of other interfaces such as RS232, RS422, RS485 or K-Line are available for diagnostic purposes.

Error frame detection

This feature allows surveillance and monitoring of a CAN network. The COMfalcon® possesses an own logic for detecting error frames and counting them up in a specific internal memory area. That is used for finding intermittent errors like falsified messages of a CAN participant.

Technical Data

CPU	Freescale PowerPC
RAM	64 MB
Memory	16 MB (for data logging optionally up to 128 MB)
CAN interface	4× CAN interface acc. to ISO 11898
Baud rates	50 Kbit/s up to 1 Mbit/s
CAN termination resistance measurement	Terminating resistor of the vehicle CAN network with active bus
CAN Port	2× 7-pole M16 port (like Sontheim CANUSB-2)
RS232 interface	D-Sub9 Plug A
Serial multiplex interface	D-Sub9 Plug A; 5 different serial interfaces, changeable via software
K-/L-Line interface	K-/L-Line (acc. to ISO 9141-2, ISO 14230-4), Baud rate up to 56 kBaud/s
RS485 interface	EIA/TIA-485 compatible Baud rate up to 10 Mbit/s no integrated termination resistor
RS422 interface	ANSI/TIA/EIA-422 compatible Baud rate up to 10 Mbit/s no integrated termination resistor
LAN	M12 4-pin female connector 100 Mbit/s LAN, D-codiert
WLAN	1× acc. to IEEE 802.11g, up to 54 Mbit/s
14-segment display	Boot information, K-line mode, RS-mode, measurement, error codes
LEDs	Power LED (green) LAN status LED (green and yellow) WLAN status LED (green and yellow) 4× CAN status LED (green and yellow) 2× RS status LED (green and yellow)
Dimensions (l×w×h)	110 mm × 150 mm × 35 mm
Housing	Aluminium, protection class IP65
Storage temperature	−40 °C up to +85 °C
Operating temperature	−20 °C up to +60 °C
Supply	a.) 6 up to 32 V DC with load-dump protection b.) via USB V = 5 V, IMAX < 500 mA (with Mini-B-USB connector)



ID-based level measurement – resistance measurement/current measurement

This feature allows to read the CAN level even IO-related and to measure active and passive termination resistors, for example for various diagnostics on a vehicle or a machine. This is especially important if the network may lose data caused for example by short circuits.

The Sontheim Modular Diagnostic Tool Chain

You can easily create your individual and professional diagnostic solution for automotive application with the help of the Sontheim interfaces and diagnostic software. Some use cases by linking hardware and software are:

- CAN data visualization, monitoring and processing
- Parameterization and control of whole CAN networks
- Vehicle diagnostics
- Flash processes of electronic control units (ECUs)

Pin assignment

RS1



1	VTRAC
2	GND
3	COM+
4	COM−
5	ISOK
6	ISOL
7	NC
8	RS422 RX+
9	RS422 RX−

CAN 1/2



1	CAN2 low
2	CAN2 high
3	NC
4	CAN1 low
5	CAN1 high
6	Ubat
7	CAN GND

RS2



1	NC
2	RS232 RX
3	RS232 TX
4	NC
5	GND
6	NC
7	NC
8	reserved
9	reserved

CAN 3/4



1	CAN4 low
2	CAN4 high
3	NC
4	CAN3 low
5	CAN3 high
6	Ubat
7	CAN GND

LAN



1	TX+
2	RX+
3	TX−
4	RX−

Order information

V930232000

COMfalcon®



COMfalcon® plus

COMfalcon® plus is a powerful VCI with WLAN/LAN and optional Bluetooth communication and various equipment options. Use it for monitoring, flashing or analyzing CAN networks and handling layer-7 protocols like CANopen or SAE J1939. Profit also from a Linux operating system and LUA scripting.

Key Features

- CAN
4× independent CAN channels
- WLAN
WLAN interface
- Bluetooth
Bluetooth optional
- RS 232
RS232
- K-Line
K-Line
- Protocolhandling
Protocolhandling
- Optional with data logging, scripting, CAN voltage level Oscilloscope functionality
- Optional with integrated SD card
- Compact housing with protection class IP65

Interfaces

The COMfalcon® plus has four independent CAN channels and a Freescale PowerPC architecture. WLAN/LAN and optional Bluetooth is used to connect to a diagnostic device. In addition to the CAN interfaces a various of other interfaces such as RS232 or K-Line are available for diagnostic purposes.

Housing and status indicators

The device has a fairly rugged housing built of aluminium with IP65 protection and a easy to use trigger button for logging data. Thanks to the compact design and high shock resistance, the VCI can be used in various fields of the automotive industry. A double 14-segment display and nine LEDs are always showing the current status/error code of the device.

LUA Scripting

Own embedded applications are running directly on the COMfalcon® plus in LUA without the need of a third device. Several scripts can be run in parallel. Among other things, it's possible to create and implement own information, such as flash routines, ECU descriptions and more, and thus, for example, access to the CAN or file system. The embedded applications are portable and reusable for future Sontheim VCI generations.

Technical Data

CPU	Freescalo PowerPC
RAM	64 MB
Memory	4 GB (up to 32 GB)
CAN interface	4x CAN interface acc. to ISO 11898
Baud rates	50 Kbit/s up to 1 Mbit/s
CAN termination resistance measurement	Terminating resistor of the vehicle CAN network with active bus
CAN Port	2x 7-pole M16 port (like Sontheim CANUSB)
RS232, K-/L-Line interface	M12 5-Pin female connector
LAN	M12 4-pin female connector 10/100 Mbit LAN
WLAN	1x acc. IEEE 802.11b,g,n,d,e,i up to 65 Mbit/s
Bluetooth (optional)	2.1+EDR, Power Class 1.5, BLE 4.0 and ANT
USB	Type mini-B
14-segment display	Boot information, K-line mode, RS-mode, measurement, error codes
LEDs	LAN status LED (green and yellow) WLAN/Bluetooth status LED (green and yellow) 4x CAN status LED (green and yellow) RS232, K-/L-Line status LED (green and yellow)
Dimensions (l×w×h)	110 mm × 150 mm × 35 mm
Housing	Aluminium, protection class IP65
Storage temperature	-40 °C up to +85 °C
Operating temperature	-40 °C up to +60 °C
Supply	via CAN 12 V – 24 V

Pin assignment

CAN 1/2



1	CAN2 low
2	CAN2 high
3	CAN GND
4	CAN1 low
5	CAN1 high
6	Vbat
7	oV

CAN 3/4



1	CAN4 low
2	CAN4 high
3	CAN GND
4	CAN3 low
5	CAN3 high
6	Vbat
7	oV

RS232 / K-/L-Line



1	RS232_RX
2	RS232_TX
3	K_Line
4	L_Line
5	GND

USB



1	VCC
2	USB_D-
3	USB_D+
4	USB_ID
5	GND

LAN (green)



1	ETH_TX+
2	ETH_RX+
3	ETH_TX-
4	ETH_RX-



Error frame detection

This feature allows surveillance and monitoring of a CAN network. The COMfalcon® possesses an own logic for detecting error frames and counting them up in a specific internal memory area. That is used for finding intermittent errors like falsified messages of a CAN participant.

ID-based level measurement – resistance measurement/current measurement

This feature allows to read the CAN level even IO-related and to measure active and passive termination resistors, for example for various diagnostics on a vehicle or a machine. This is especially important if the network may lose data caused for example by short circuits.

The Sontheim Modular Diagnostic Tool Chain

You can easily create your individual and professional diagnostic solution for automotive application with the help of the Sontheim interfaces and diagnostic software. Some use cases by linking hardware and software are:

- CAN data visualization, monitoring and processing
- Parameterization and control of whole CAN networks
- Vehicle diagnostics
- Flash processes of electronic control units (ECUs)

Order information

V930232400







COMfalcon® plus



OBDfox

**Smart CAN-to-Bluetooth Gateway
with OBD interface.**

Key Features

-  **1× CAN interface acc. to ISO 11898**
-  **1× Bluetooth 4.1**
-  **1× 3D acceleration sensor (optional)**
-  **12 V or 24 V compatible**
-  **Extremely compact**
-  **IP20 protection class**

Smart CAN-to-Bluetooth gateway

The very compact OBDfox is equipped with a CAN interface according to ISO 11898-2. By means of an OBD connection, the VCI can easily be connected to a vehicle and the data can be sent via Bluetooth to a smartphone, tablet or mobile device (Android and IOs compatible). An optional 3D accelerometer enables notification in case of unauthorised use of the machine (anti-theft protection) or provides useful information for repair and maintenance work, for example after very hard vehicle vibration.

Technical Data

CPU	32-bit microcontroller, Cortex-M4/M0
Memory	2 MB SPI-Flash
CAN	1x CAN interface acc. ISO 11898-2 (2x CAN optional)
Bluetooth	4.1 + LE, BR/EDR
3D Acceleration sensor	1x, optional with $\pm 2g$, $\pm 4g$, $\pm 8g$
Status	2x LED
Dimensions (l×w×h)	61 mm × 45 mm × 22 mm
Operating temperature	0°C up to +60°C
Storage temperature	-20°C up to +85°C
Protection classification	IP20
Power supply	12 V or 24 V compatible



Integrated MT-API interface

The integrated API allows a fast and easy realization of OEM applications. The OEM can thus implement his own CAN plug and play functionalities for his vehicle efficiently and quickly. With OBDfox it is possible to check the connectivity on the CAN bus or to perform live monitoring of the machine data. In addition, the device provides a simple overview of relevant operating and service data and can execute simple diagnostic applications.

Your compact OBD to Bluetooth solution









With only 61 mm × 45 mm × 22 mm the OBDfox is very compact. You can easily plug it on every OBD interface, regardless of how much space you have (glovebox, armrest, center console, ...). The compact gateway fits in every pocket and is ready to use anytime.



ISOfox

Smart ISOBUS gateway with Bluetooth

Key Features

-  **1× CAN interface acc. to ISO 11898**
-  **1× ISOBUS acc. to ISO11898**
-  **1× Bluetooth 4.1**
-  **12 V or 24 V compatible**
-  **Extremely compact**
-  **IP20 protection class**
-  **Trigger Button**
-  **1× WLAN (optional)**

Smart ISOBUS Gateway

The very compact ISOfox is equipped with one ISOBUS interface according to ISO 11783 and one CAN interface according to ISO 11898-2. You can simply connect the device to the ISOBUS and the data is sent via Bluetooth or WLAN (optional) to a smartphone, tablet or mobile device. The VCI is compatible with any ISOBUS tractor or implement.

Technical Data

CPU	32-Bit Microcontroller, Cortex-M4/M0
RAM	32 MB SDRAM
Memory	4 GB up to 64 GB eMMC NAND Flash
CAN	1x acc. to ISO 11898-2
ISOBUS	1x acc. to ISO 11783
Bluetooth	1x 4.1 + LE, BR/EDR
WLAN (optional)	1x IEEE 802.11 b/g/n WPA/WPA2, WEP, TLS/SSL, HTTPS, TCP, UDP, DHCP, DNS
Status	3x LED, 14-segment display
Dimensions	74 mm × 40 mm × 40 mm
Operating temperature	0°C up to +60°C
Storage temperature	-20°C up to +85°C
Protection classification	IP20
Power Supply	12 V or 24 V compatible



Integrated MT-API interface

The integrated API of ISOfox allows a quick and easy realization of OEM applications. The OEM can thus implement his own ISOBUS plug and play functionalities for his vehicle efficiently and quickly. With ISOfox it is possible to check the connectivity on the ISOBUS or to perform live monitoring of the machine data. In addition, the device provides a simple overview of relevant operating and service data and can execute simple diagnostic applications.

Your compact ISOBUS gateway solution

With only 74 mm × 40 mm × 40 mm the ISOfox is as small as a standard ISOBUS connector. You can easily plug it on every ISOBUS interface, regardless of how much space you have (glovebox, armrest, center console, ...). The compact gateway fits in every pocket and is ready to use anytime.

Order information

V930351100	ISOfox
------------	--------



CANfox®

The CANfox® is a VCI of the Sontheim fieldbus-to-USB adapter. Besides its CAN interface it contains a RS232 channel for a maximum of flexibility. The device can be used for monitoring of CAN networks, setting parameters of machines or vehicles etc.

Key Features

CAN

1× galv. isolated CAN interface acc. to ISO 11898

RS 232

1× RS232



Connection via USB 2.0



Free configuration of baud rate including 800 Kbit/s

32 bit

Powerful 32-bit microcontroller



CODESYS Gateway-driver available

MT-API

Multi-Thread API for own applications



Driver for Windows 2000 up to Windows 10 with 32- and 64-bit

Housing and interfaces

It is housed in a compact plastic case and offers one RS232 and one galvanic isolated CAN interface. This is implemented via a D-Sub9 connector according to CiA standard. Its USB 2.0 interface enables the CANfox® to be used at any laptop, embedded PC or desktop PC. Once you have installed the driver you will benefit from hot plug and play, which is a connection of device to PC without restart. Consequently, CANfox® offers all necessary interfaces located in a tiny case for mobile or stationary use.

More performance, less costs

It is a powerful device within the Sontheim interface group with its 32-bit microcontroller for data-handling. However, the CANfox® is meant to be a flexible and very inexpensive tool. Thus, you can configure the baudrate via software and adapt it to your processes.

Technical Data

CPU	32-bit Microcontroller
CAN	1x CAN interface acc. to ISO 11898, via D-Sub9
RS232	1x RS232 interface, via D-Sub9
USB	1x Standard USB Typ A, 75 cm cable length
Baud rates	50 Kbit/s up to 1 Mbit/s, free configuration
Max. Data transfer	1 Mbit/s at 90% Bus load
LEDs	3x 3 mm LED
Housing	compact plastic
Operating temperature	-20 °C up to +60 °C
Storage temperature	-40 °C up to +85 °C
Rel. Humidity	20% – 90% non-condensing
Power supply	via USB interface
CANAPI (=Windows DLL)	Windows 2000, XP, Vista, 7, 8; 32-bit. Windows 98 on request

Pin assignment

USB



1	VCC (VBUS)
2	- Data
3	+ Data
4	GND

CAN



2	CAN low
3	CAN Ground
7	CAN high

RS232



2	TXD
3	RXD
5	GND

Comprehensive software support

Of course, CANfox® is supported by all Sontheim tools like CANexplorer 4 for CAN bus diagnostics or MDT® for vehicle applications like diagnostics or End-of-Line processes. With the help of the included software interface (API), users can also run their own software. There is also a CODESYS support implemented in order to use the device for PLC and motion control tasks. Use it as a programming gateway for CODESYS-based PLCs or for downloading programs directly out of a CODESYS programming environment.

The Sontheim Modular Diagnostic Tool Chain

You can easily create your individual and professional diagnostic solution for automotive application with the help of the Sontheim interfaces and diagnostic software. Some use cases by linking hardware and software are:

- CAN data visualization, monitoring and processing
- Parameterization and control of whole CAN networks
- Vehicle diagnostics
- Flash processes of electronic control units (ECUs)

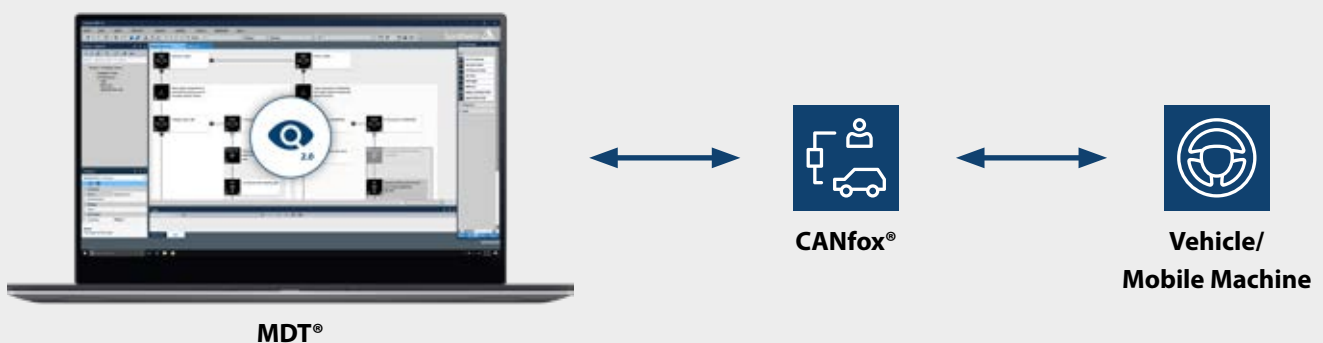

Order information

V930322000

CANfox®



CANUSB

This is a top seller among the Sontheim VCI family. It facilitates a quick and sturdy connection between PC or notebook and CAN bus. CANUSB is highly flexible, user-friendly and market-proven. Thousands of units are already in the field, used for monitoring of CAN networks, setting parameters of machines or vehicles etc.

Key Features



Shock-resistant aluminium extrusion housing



1 or 2 galv. isolated CAN channels with 1 Mbit/s transfer capacity at 90 % bus load



Hot plug and play ensures fast and convenient commissioning



MT-API enables access to CAN bus for own applications



Optional variant with error frame detection



Ideal for use with a PC or notebook

Housing

The device has a fairly rugged housing built of aluminium. Its compact design and resistivity against shock make it very popular in many areas of the automation and automotive industry.

CAN channels

There are either one or two galvanically isolated CAN channels available which comply with ISO 11898-2. The transfer rate ranges up to 1 Mbit/s at 90 % bus load.

Flexible data processing

Its USB 2.0 interface enables the CANUSB to be used at any laptop, embedded PC or desktop PC. Once you have installed the driver you will benefit from hot plug and play, which is a connection of device to PC without restart.

CPU and firmware update

The Motorola STAR12 and the Philips PDIUSB12 guarantee a quick data processing. Both CAN 2.0 A and CAN 2.0 B are supported. CANUSB is suited for numerous operating systems like Windows XP, XP embedded, Vista and 7. All firmware updates can be loaded via USB.

Technical Data

CPU CAN	Motorola Star12, 16-bit
CPU USB	Philips PDIUSB12
CAN	1x CAN interface acc. to ISO 11898-2, galv. isolated (optional 2x CAN)
USB	1x USB 2.0
CAN connection	1x 7-pin round plug
USB connection	1x standard USB connector type A
Cable CAN	optional 2 m CANUSB cable
Cable USB	1 m Standard USB
Max. Data transfer	1 Mbit/s at 90 % bus load
Error frame detection	optional
Analog level measurement	integrated
LEDs	2x triple 3 mm LED angled
Dimensions (l×w×h)	100 mm × 57 mm × 32 mm
Weight	166 g
Housing	Solid aluminium
Operating temperature	0°C up to +70°C
Storage temperature	-20°C up to +85°C
Rel. Humidity	20 % - 90 % non-condensing
Power consumption	max. 350 mA at 5 V
Power supply	via USB interface

Pin assignment

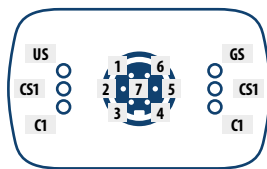

CAN

US	USB Status
CS1	CAN Status 1
C1	CAN 1 receive / transmit action
GS	Device status
CS2	CAN Status 2
C2	CAN 2 receive / transmit action
1	CAN2 low
2	CAN2 high
3	-
4	CAN1 low
5	CAN1 high
6	-
7	CAN GND

USB

1	VCC (VBUS)
2	- Data
3	+ Data
4	GND

Order information

V930204000	CANUSB, 2x CAN, Errorframe, level measurement
V930205000	CANUSB, 2x CAN, Errorframe
V930206000	CANUSB, 2x CAN
V930207000	CANUSB, 1x CAN, Errorframe, level measurement
V930208000	CANUSB, 1x CAN, Errorframe
V930209000	CANUSB, 1x CAN
V930220000	CANUSB-cable, 2 m, 120 Ohm
V930220100	CANUSB-cable, 2 m, (2x D-Sub9 male)

Error frame detection

This feature allows surveillance and monitoring of a CAN network. The CANUSB possesses an own logic for detecting error frames and counting them up in a specific internal memory area. That is used for finding intermittent errors like falsified messages of a CAN participant.

Level measurement

This feature is designed for an analog measurement of CAN levels. It is used for doing diagnostics at vehicles of all kinds or machines. It is especially important when data is lost from the network, which can be caused by short circuits, for example.

Programming interface

The CANapi provides all functions for programming own applications. It supports all Sontheim interfaces and several third-party devices which is why we enclose our SiECA132 MT-CANapi with four simultaneous handles at every interface dongle.

The Sontheim Modular Diagnostic Tool Chain

You can easily create your individual and professional diagnostic solution for automotive application with the help of the Sontheim interfaces and diagnostic software. Some use cases by linking hardware and software are:

- CAN data visualization, monitoring and processing
- Parameterization and control of whole CAN networks
- Vehicle diagnostics
- Flash processes of electronic control units (ECUs)

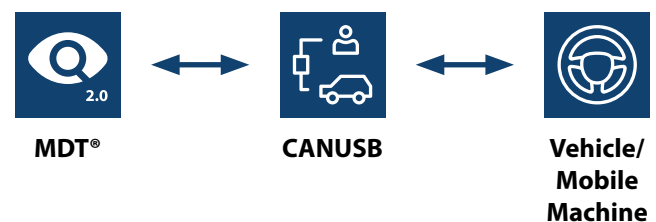





D-PDU-API

Vehicle access via standardized D-PDU-API according to ISO 22900-2

Key Features

-  **Standardized vehicle access**
-  **Support of the Sontheim VCIs**
-  **Easy integration into the MDT®**

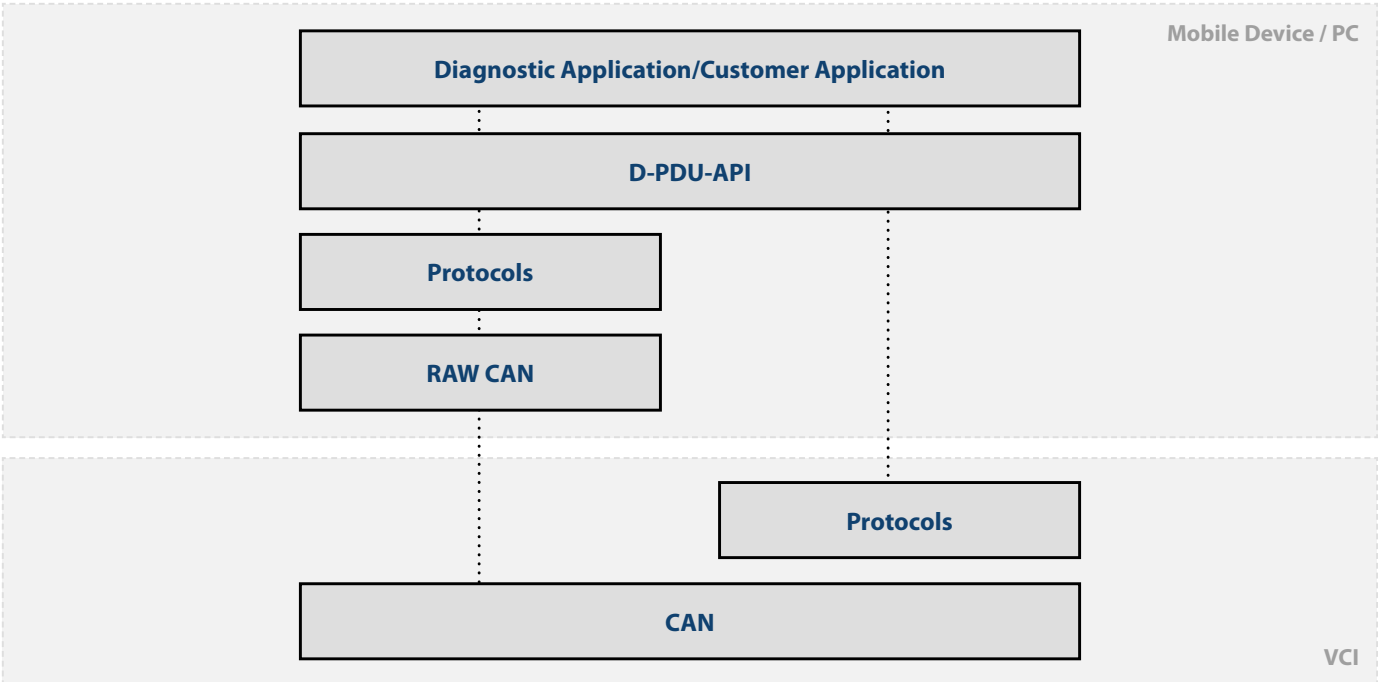





SAE J2534 API

PassThru API

Key Features

-  **Standardized vehicle access**
-  **Support of the Sontheim VCIs**
-  **Easy integration into the MDT®**

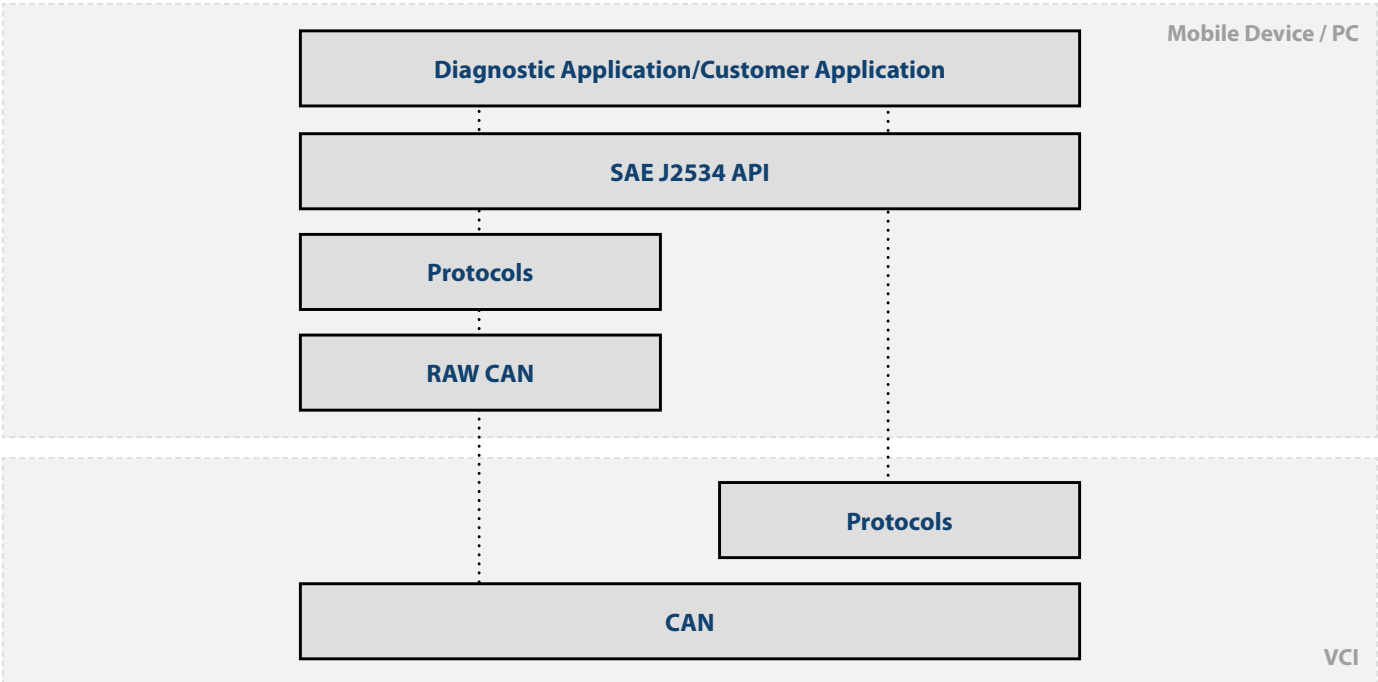



Protocol Stacks

DoIP, UDS and more protocol stacks available in our portfolio

Key Features



Very performant and stable programming



Modular design



Individual adjustments easy to implement



Unified Diagnostic Service (UDS) Stack acc. to ISO 14229



DoIP Transport Protokoll Stack acc. to ISO 13400



Transport protocol for UDS and KWP2000 acc. to ISO 15765



Diagnostic event manager for UDS and J1939



Flashbootloader (developed acc. to ISO 25119 SRL-2)



CAN basic driver for your platform

Performant protocol stacks – standard based and proprietary

A performant programming and clearly defined interfaces are essentially important for the creation of protocol stacks. Based on standards and proprietary customer-specific requirements that set the rules of communication, the Sontheim Industrie Elektronik GmbH has already developed several stacks for various application areas.

Great expertise with different communication protocols

For implementing your customized solution we can fall back on the already-implemented stacks such as Device-Net, J1939-21 including address claiming, J1939-73 (DM1 and DM2), KWP 2000, UDS, CANopen slave and master, to support you optimally. Due to our extensive experience in the development of protocol stacks and our modular software architecture, we can implement at any time individual and proprietary protocol stacks and integrate it into our software products.

Many years of experience with various microcontroller platforms

Our protocol stacks were often ported by us on various hardware platforms and microcontrollers, such as PowerPC, ColdFire MCF548x, Infineon XC164CS, Atmel AT89C51CC03C ARM7 LPC2458, Star12, HC12.

Real time for critical applications

In the field of automation technology we employ our CAN stacks in real-time environments and so we can offer as an example control PCs, which are suitable for critical applications, such as complex systems.

From the application to the hardware

Of course, it is also possible to implement proprietary protocols. We have already several basics by different customer-specific projects, which have been successfully implemented. PC side as well as in the embedded sector, we have specific know-how. In addition, a quick integration is facilitated by the modular design in your system and we like to develop a custom solution for you. With the Sontheim Flash boot loader we offer a tailor-made solution for your system. Our fast and efficient solutions are already in many systems in use and allow a reliable boot up process, as well as software programming. In addition to the stacks, the HAL and the drivers for hardware, you receive also hardware components such as CAN interfaces and industrial PCs and control units.

Schematic structure of the stack and the flash bootloader

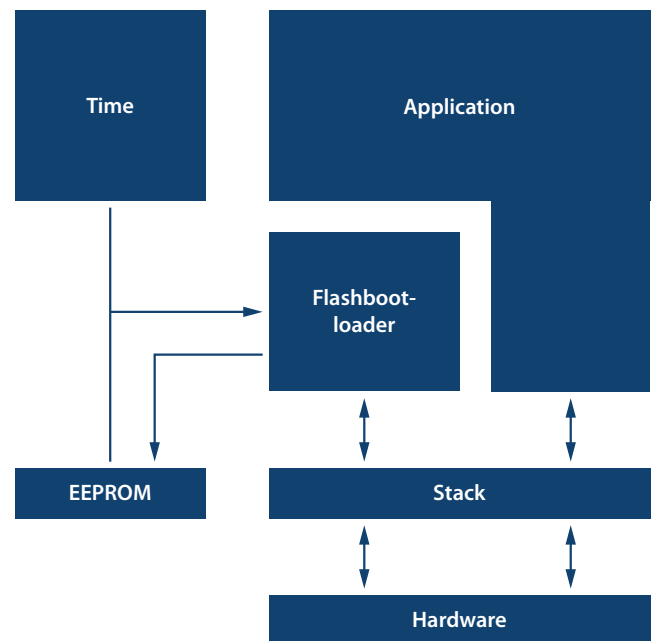
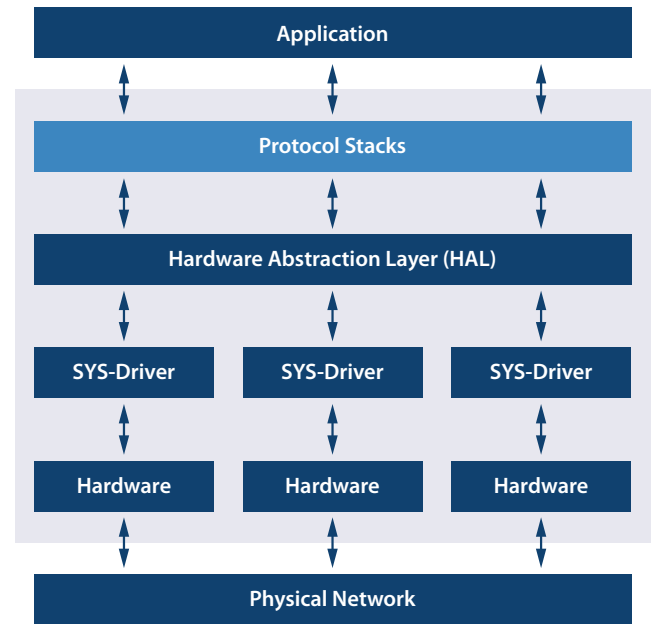

For specific voting requirements and a customized solution, we provide you with a team of project managers and software specialists. If you are interested we are looking forward to your request!

CANexplorer 4



Modular, intuitive, efficient – CANexplorer 4 is a completely new developed field bus-analyzing software which represents the huge know-how in working with CAN networks in complex machines and vehicles. The new generation obtains a significantly enhanced range of functions and an improved handling. This makes the CANexplorer 4 a very intuitive and powerful tool.

Key Features



User-defined measurements setups with graphic elements and Drag and Drop



Receive, edit, transmit and abstract raw data



J1939-protocol support



CANopen-protocol support



Modular design with expansion options



Import and export from signal databases

Data processing

CANexplorer 4 offers various functions for processing CAN data, e.g. classical text-based traces, graphs, bar graphs, LEDs, filters and triggers. Generating a test set-up can be carried out by connecting different functional elements via Drag and Drop. This enables the software to consequently display complex processes in a visual and common manner.

Visualization

You can adapt the data visualization by defining triggers and filters. It is also possible to take an active part in the bus communication and generate and transmit messages that are also shown in a visualization. Have your telegrams sent manually, fully automatic or via trigger.

Data abstraction

Use an integrated protocol abstraction for automatically interpreting data to CANopen and J1939. The CAN data is then available as pre-processed and readable information. Further protocol stacks can easily be added with updates. All proprietary protocols and RawCAN data can be processed with a manual symbol editor. This tool is used for defining symbols and translating the payload of a CAN frame into comprehensible values.

Parallel processes

CANexplorer 4 obtains a multi-thread support for parallel usage next to other applications running on a PC and the visualization of various modules at the same time.

Overview of the most important modules:

Input:

CANexplorer 4 obtains various possibilities for manually or automatically creating CAN data as well as reading CAN messages at the bus.



Signal generator Transmit

Creation of signal processes.
Fast access to pre-defined CAN messages.



Replay

Replay of previously recorded CAN log-data for an analysis of the CAN bus data.
It is possible to apply original time-settings of the records.



Hardware Inputs

Receiving and transmitting of CAN data. All Sontheim interfaces are supported, e. g. CANUSB, CANUSBlight and PowerCAN.

Processing:

Different filters provide a comfortable handling of the various CAN data. Moreover, the user can abstract the data to J1939 and CANopen.



Filter

One can use filters for CAN identifier, areas of CAN identifier, data bytes and message types. The filters have a positive and a negative output.



Protocol Filter

The integrated filters J1939 and CANopen offer an abstraction and pre-processing of CAN bus data traffic.



Trigger

Creation of an event which can start a pre-defined operation. The user can choose between different triggers (e. g. data bytes or data bits) for a maximum of flexibility.

Visualization And Recording:

The modular-based design of the CANexplorer provides individual adaptation of the visualization and the display of specifically required data. The CAN bus traffic can be recorded and visualized easily via different elements. Of course, the various instruments can be chosen and configured according to the user's requirements.



Log Module

Easy writing of CAN messages into a log-file.



Trace

Tabular display of CAN messages in the static or trace mode.



Graph

Visualization of signals via graphs. Underlining events via placing of markers.



Signal Monitor Symbol Editor Bar-Graph Statistic

Display of signals in a table, including minimum and maximum. Definition of symbols down to the Bit layer for a simplified and more lucid illustration of CAN information. Visualization of signals via bar-graphs or tachometer. Indication of bus statistics (e.g. amount of received / transmitted messages, bus-charge and others).

Technical Data

Operating system	Windows 2000 SP4, XP, Vista (32-Bit), 7, 8, 10
CPU	1.6 GHz Intel Pentium
RAM	512 MB
Graphics	1024x768 px, 16 mio. colors
Minimum hard disk space	min. 80 MB
Supported CAN Hardware	COMfalcon® CANUSB CANfox® CANUSBlight PowerCAN-PCI V1 and V2 PowerCAN-PCI04+ PowerCAN-PCI04 V2 Other CAN hardware available upon enquiry

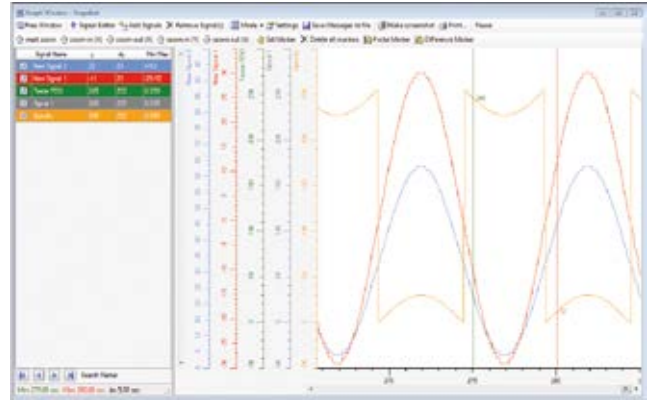

Features

Receiving and transmitting CAN messages	Signal generator with different signals (sinus, saw tooth, rectangle) Manual transmitting of definable CAN messages Cyclic transmitting of definable CAN messages Transmitting in block mode
Filter	CANexplorer 4 supports filtering for identifier, data bytes, symbols and message types
Trigger	Canexplorer 4 uses pre- and post-trigger
Signal datenbase	Saving of messages in a database as well as visualization via texts and graphic elements for intuitive handling Editor for generating and processing of signals (message, multiplexer, key, groups and signal) For both data import and export there are various data types supported
Visualization	Trace, graph, bar-graph, tachometer, symbol-monitor
Data processing	Writing in log-file, replay mode
Protocol support	RawCAN, CANopen, J1939, implementation of proprietary protocols upon enquiry
Bus statistic	Overview of transmitted and received messages bus-charge and CAN levels
Quick Trace	Quick monitoring of the CAN channels without previous creation of a test setup

Order information





V940340010	CANexplorer 4 Basis
V940340099	Software maintenance
V940340020	Extended graph
V940340021	Extended measurement setup
V940340022	BarGraph & Tacho, LED
V940340023	Protocol filter J1939
V940340024	Protocol filter CANopen
V940340025	Signal-generator
V940340026	DBC-import & export
V940340027	ASC-support
V940340029	Vector-support for CANcardXL
V940340030	Peak-support for PCAN-USB



BOB 2 L6

Breakout box for the connection of various measurement setups

Key Features

-  **2× analysis plug, 5× CAN interface acc. to ISO 11898, 1× serial**
-  **Simple cabling**
-  **Cross-plant and multidisciplinary project**
-  **Solid aluminium housing for top hat rail mounting**

Technical Data

Analysis plug	2× analysis socket (D-Sub25)
CAN	5× CAN interface acc. to ISO 11898 (D-Sub9)
Serial Trace	1× serial interface (D-Sub9)
Dimensions (l×w×h)	121 mm × 120 mm × 81.5 mm
Weight	ca. 400 g
Operating temperature	0°C up to +60°C
Storage temperature	-20°C up to +70°C
Humidity	90 % non-condensing
Protection class	IP20

Overview

Breakout box is designed for simple wiring and connection of numerous different measurement setups via analytics interfaces. It is a device that covers different branches and divisions and can be used for all vehicles starting at L6. All necessary pins of the analytics plugs 1 & 2 are being lead through. In addition to the Breakout box, there are also adaptor cables for the analytics interfaces 1 & 2 as well as a connection cable and an Y-cable for interface 3 (Flex Ray) available. A key advantage of the little device is in its easy-to-handle interfaces. They are all pluggable via banana jacks and D-Sub plugs. The module itself is made of rigid aluminium with a top hat rail for easy assembly.

Interfaces

Interfaces are all located on the front cover resulting in a fast and clearly arranged wiring. Overall, there are five CAN interfaces and two D-Sub25 female interfaces for analytics plugs available. The Serial Trace interface is made for D-Sub9. Besides that Breakout box offers ten interfaces for banana jacks that have a LED for signaling a connected plug.

Connectivity

Telemetry Gateways, Cloud Software













COMhawk®

COMhawk® is a control device for communication and diagnostic tasks. In addition to the standard interfaces such as CAN and Ethernet the module also offers a WLAN interface. The variety of interfaces and the extremely rugged IP69K housing opens the module various fields of applications in the automotive and automation area.

Key Features

-  **Powerful 32-bit microcontroller**
-  **3× CAN interface acc. to ISO 11898 (opt. 4× CAN)**
-  **1× Ethernet, 10/100 Mbit/s**
-  **WLAN acc. to IEEE 802.11 b/g/n**
-  **Data-logging**
-  **Protection class IP69K**
-  **Vibration protected**

Housing and interfaces

The new COMhawk® is equipped with up to four CAN channels, Ethernet, Wi-Fi and optional two digital inputs and one digital output. In addition, great emphasis was placed on an extremely robust and durable design to meet the current safety standards. The control device is designed for the use outside the cabin of a vehicle and is vibration tested. A temperature range of -40°C to $+85^{\circ}\text{C}$ and the compact housing with protection class IP69K are ensuring an extensive protection.

Wide field of applications

A powerful 32-bit microcontroller allows even the most demanding applications and thanks to the built-in NAND flash memory of up to 16 GB amounts of data can be stored. Thus COMhawk® can be used both, in the automotive as well as in the automation industry for a variety of communication and diagnostic tasks such as a communication interface, gateway, event logger or telemetry node.

Technical Data

CPU	32-bit microcontroller, SPC 5123 400 MHz
RAM	32 MB up to 256 MB
Memory	16 MB up to 16 GB NAND Flash Memory
CAN	3× CAN acc. to ISO 11898 (optional up to 4× CAN)
Ethernet	1× Ethernet, 10/100 Mbit/s
WLAN	1× IEEE 802.11 b/g/n
IOs	optional 2× DI optional 1× DO
Operating system	RTOS (μC/OS-II) or LINUX
Plug	18-pole Automotive Plug
Housing	IP69K
Dimensions (l×w×h)	approx. 130 mm × 124 mm × 38 mm
Weight	375 g
Operating temperature	−40 °C up to +85 °C
Storage temperature	−40 °C up to +85 °C
Power supply	6 – 32 V DC

Comprehensive software support

The freely programmable and real-time capable ECU system can be programmed by the user application specifically. Over a configurable data interface for example an individual configuration of the interfaces or the structure of an application could be solved expeditiously. Furthermore control loops can be mapped easily over an integrated script interpreter. Another advantage is the reusability of this type of programming, whereby future work can even be more efficient. The user profits from a complete development environment.

Pin assignment

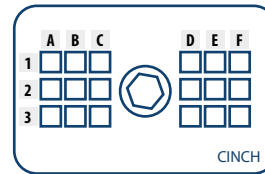

COMhawk®

1A	Ubat
1B	GND
1C	LAN_SHLD
2A	DIG_IN1 (opt.)
2B	LAN_RX−
2C	LAN_RX+
3A	DIG_IN2 (opt.)
3B	LAN_TX−
3C	LAN_TX+
1D	DIG_OUT1 (opt.)
1E	CAN4_High (opt.)
1F	CAN4_Low (opt.)
2D	CAN3_Low
2E	CAN2_Low
2F	CAN1_Low
3D	CAN3_High
3E	CAN2_High
3F	CAN1_High

Block Diagram

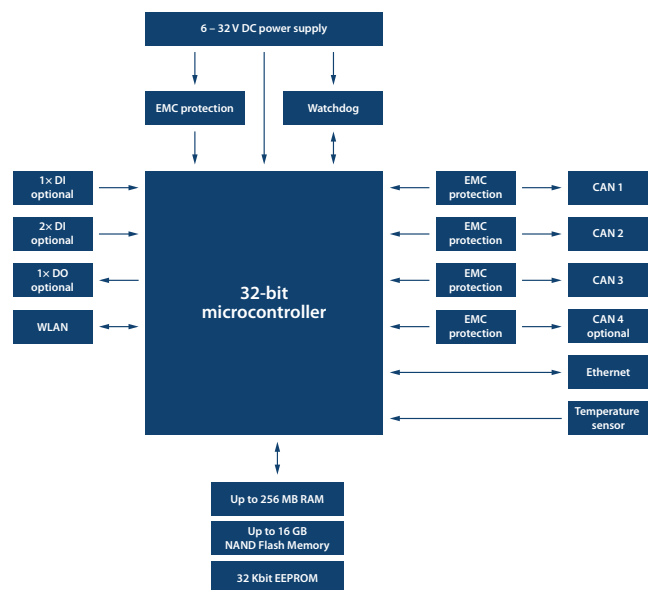

Order information

V930238200









COMhawk®



COMhawk® xt

COMhawk® xt is an embedded application ECU for telemetry and diagnostic tasks. A variety of interfaces and the extremely rugged architecture opens the module various fields of applications for mobile machines.

Key Features

-  **Powerful ARM Cortex A9**
-  **4× CAN interface acc. to ISO 11898**
-  **GNSS**
-  **2G/LTE**
-  **WLAN acc. to IEEE 802.11 b/g/n**
-  **1× Ethernet, 10/100 Mbit/s**
-  **Data logging**
-  **Vibration protected**
-  **IP67**

Communication interfaces and position determination

The new COMhawk® xt is equipped with four CAN channels and a Ethernet connection. For wireless data exchange, WLAN and LTE CAT4 mobile radio connection are available. The COMhawk® xt is also optional equipped with a GNSS receiver for position determination. Further equipment includes four digital outputs and one digital input (500 mA).

Wide field of applications

COMhawk® xt can be used for many applications from a simple data logger, which wirelessly transmits the recorded operating data, right up to the central communication, telemetry and diagnostic gateway, which unites different communications standards. Thanks to a temperature range of -20°C to $+80^{\circ}\text{C}$ and the compact housing with protection class IP67, the device is ensuring an extensive protection, even were vibrations and temperature are at their maximum. A Linux operating system provides an easy and optimal basic for creating OEM-applications in a fast way and without any further costs.

Technical Data

Processor	32-bit microcontroller, Cortex-A9 (single/dual core)
RAM	512 MB DDR3 RAM (opt. up to 1 GB)
Memory	16 GB eMMC NAND Flash (opt. up to 64 GB)
CAN	4× CAN acc. to DIN ISO 11898
Ethernet	1× Ethernet, 10/100 Mbit/s
WLAN	1× IEEE 802.11 b/g/n; Client- and Accesspoint-Mode (FAKRA E green)
GNSS	GPS/GLONASS, Beidou (FAKRA C blue)
2G/LTE	LTE CAT4 (FAKRA D violet)
IOs	4× DI, 1× DO (500 mA)
RTC	With 2 weeks buffer
Connector	30-pole automotive connector
Antenna connection	external; 3× FAKRA (opt. SMA)
Operating system	LINUX
Housing	IP67
Dimensions (l×w×h)	about 130 mm × 124 mm × 38 mm
Weight	app. 375 g
Operating temperature	-20 °C to +80 °C (higher temperature classes on demand)
Storage temperature	-40 °C to +85 °C
Power supply	6-32 V DC, incl. load dump protection
SIM Card	Including Sontheim SIM
Certifications	Europe



Block Diagram

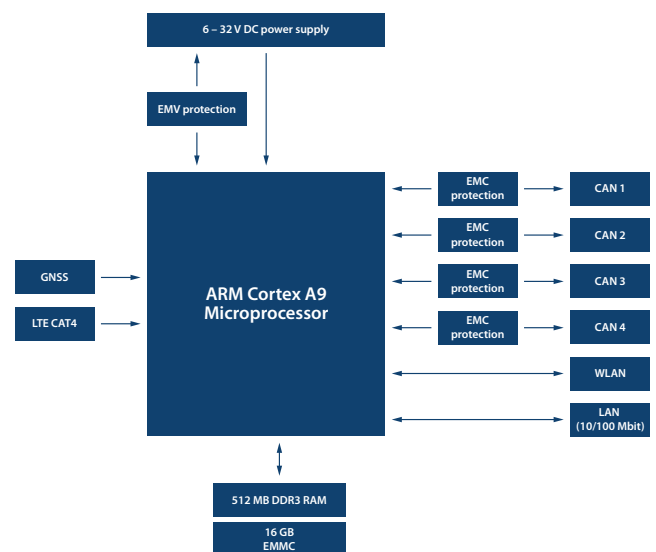

The Sontheim Modular Diagnostic Tool Chain

You can easily create your individual and professional diagnostic solution for automotive application with the help of the Sontheim interfaces and diagnostic software. Some use cases by linking hardware and software are:

- CAN data visualization, monitoring and processing
- Parameterization and control of whole CAN networks
- Vehicle diagnostics
- Flash processes of electronic control units (ECUs)

Order information

V930238600	COMhawk® xt
V966306450	Hirschmann Antenna
V940871100	IoT Device Manager
V940871200	IoT Analytics Manager

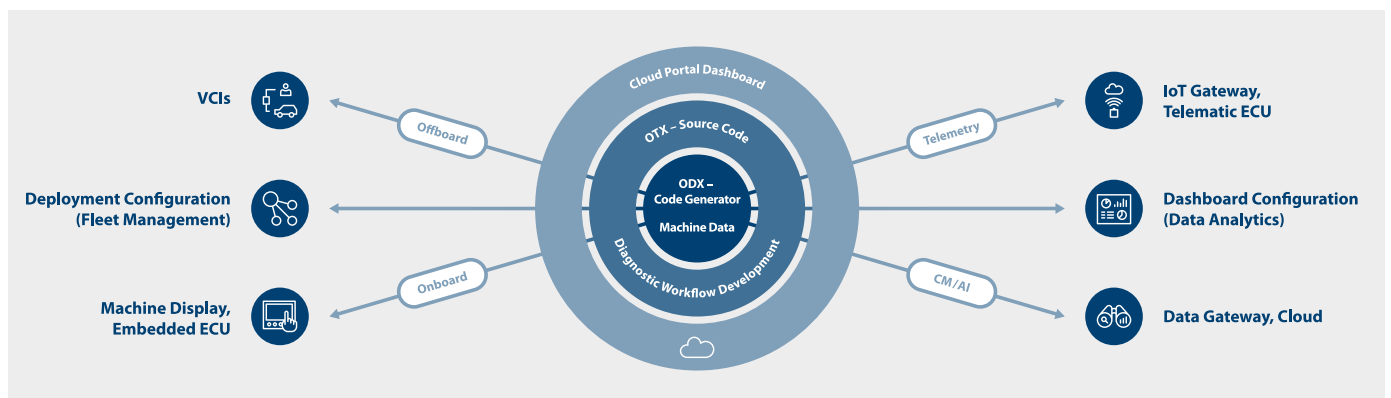







COMhawk[®] xt light

COMhawk[®] xt is an embedded application ECU for telemetry and diagnostic tasks. The cost-optimized light version enables simple telematics tasks with an optimal price-performance ratio.

Key Features

-  **1× CAN interface acc. to ISO 11898 with J1939 Protocol Support**
-  **2G/LTE**
-  **FOTA (Flash-over-the-air)**
-  **Protection class IP67**

Interfaces and mobile communication

The new COMhawk[®] xt light has one CAN channel with J1939 protocol support. A 2G/LTE mobile radio connection is available for wireless data exchange. This can be used to run FOTA applications, which can be managed by our IoT Device Manager.

Wide range of applications

COMhawk[®] xt light can be used in various applications of mobile machines, but also in stationary machines. From a simple IoT gateway, which transmits the recorded operating data wirelessly, to a central communication, telemetry and diagnostic gateway, the range of applications is wide. The extended temperature range from -30°C up to $+70^{\circ}\text{C}$ and the compact housing with IP67 protection guarantee comprehensive protection. The embedded operating system also offers a simple and optimal basis for creating OEM applications without increased effort and costs.

Technical Data

CPU	32-bit microcontroller
CAN	1x CAN interface acc. to ISO 11898
Further protocols	J1939
2G/LTE	GSM/GPRS/EDGE/LTE
Antenna connection	internal
Housing	IP67
Dimensions (l×w×h)	approx. 120 mm × 111 mm × 34 mm
Weight	260 g
Operating temperature	−30 °C up to +70 °C (higher temperature class on request)
Storage temperature	−40 °C up to +85 °C
Power supply	6–32 V DC



IoT Device Manager

The IoT Device Manager is a cloud-based tool for simple and clear management of your telematic units in the field. You can group and structure your devices via drag and drop and can manage software packages for over-the-air updates.

Collect live data during vehicle operation or flash software over-the-air via:

- Mobile networks (2G/LTE)

Store telemetry data for further analysis to support:

- QA statistics
- Usage statistics
- Servicing intervals
- Vehicle Lifecycle Support
- After sales offerings

IoT Analytics Manager

The IoT Analytics Manager is a cloud-based tool for storing and visualizing your operation data (big data).

An OEM is able to analyze and evaluate data in different configurable dashboards, widgets and histograms. The data amount and traffic can be individually set up for different use cases. Furthermore, a live data integration for real-time monitoring is also possible and can be individually configured by the customer.

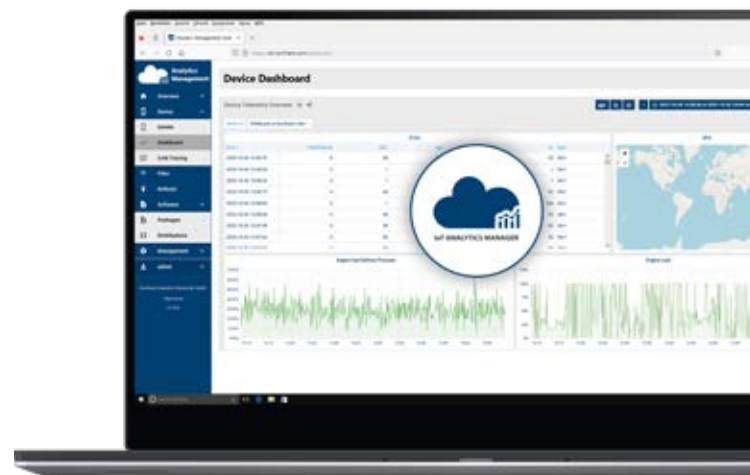
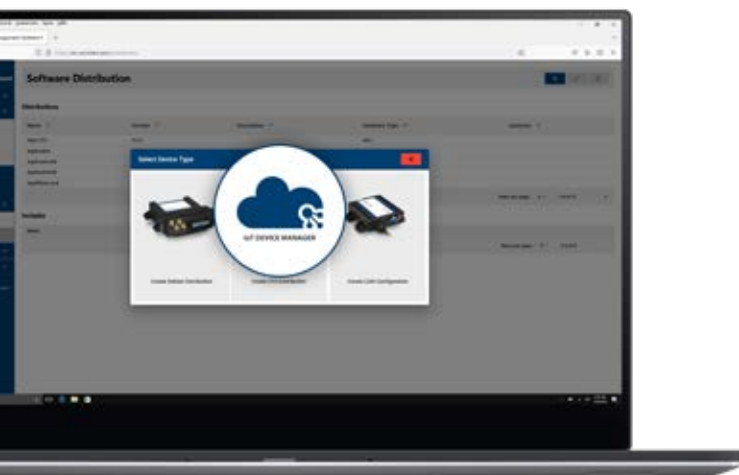



Beacon BT

Smart and ultra-compact Bluetooth module with integrated battery supply and extended version with accelerometer

Key Features



Bluetooth 5.0 Low Energy



Optional accelerometer with $\pm 16/24$ g



IP67 protection class



Casted electronics



Operating temperature -40°C to $+65^{\circ}\text{C}$



CE certified

Make your machines smart – with the extremely compact Bluetooth node from Sontheim. Thanks to a size smaller than a bank card, the module can be easily and specifically be attached to almost all machines. With an integrated memory of 2 MB, data of the connected machine can be stored (10-digit identification number, 4×128 byte data) and retrieved via Bluetooth. Thus, for example, the presence, operating hours or special operation modes can be transmitted and queried easily and efficiently. In addition, the module can be seamlessly integrated into the infrastructure of our COMhawk[®] xt telemetry series.

Information from the machine can thus be recorded via Bluetooth and transferred to a cloud for further analysis using the telemetry module. Various operating modes can be recorded, categorized and made available via an additionally integrated acceleration sensor (Beacon BTA variant). With its casted electronics and an IP67 protection class, the module offers the necessary protection for harsh environmental conditions and installation outside the cabin. An operating temperature of -40°C to $+65^{\circ}\text{C}$ and CE certification round off the overall package.

Technical Data

Bluetooth	5.0 Low Energy
Memory	2 MB
Accelerometer	±16/24 g (Beacon BTA variant)
Protection Class	IP67 (casted electronics)
Dimensions (l×w×h)	app. 75 mm × 43 mm × 17 mm
Weight	app. 53 g
Battery	Integrated, life expectancy 7–10 years
Operating temperature	−40 °C up to +65 °C
Storage temperature	−40 °C up to +85 °C



Possible Communication Beacon BT

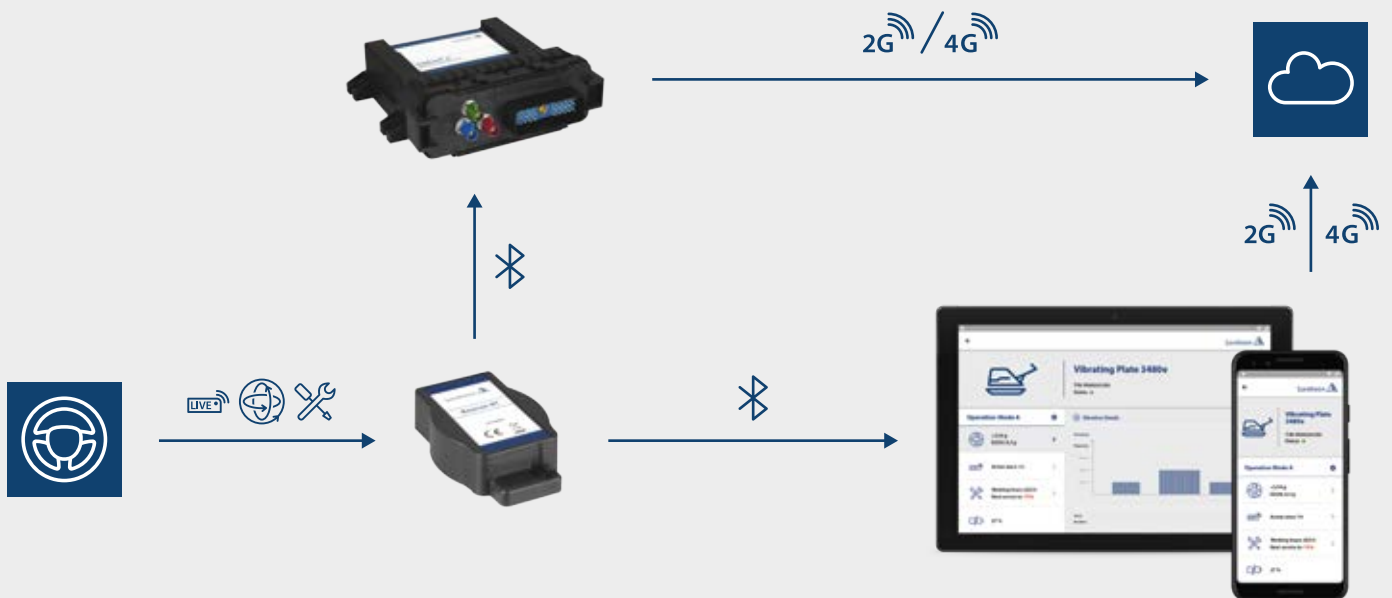



IoT Device Manager

Cloud-based platform for managing your devices in the field.

Key Features



Management of all telematics units



Drag and drop functionality



Managing updates over-the-air



Simple configuration of all devices



Fast data consumption analysis



Live data monitoring

The IoT Device Manager is a cloud-based tool for the simple and clear management of your telematics units in the field. You can group and structure your devices by drag and drop and manage software packages for wireless over-the-air updates.

Collect live data during vehicle operation or flash software wirelessly:

- Mobile networks (2G/LTE)
- WLAN

Store telemetry data for further analysis and support the following functions:

- QA Statistics
- Usage statistics
- Planning of service intervals
- vehicle lifecycle support

Store telemetry data and check information such as:

- SIM card number (IMSI)
- Serial number of the LTE device
- Last connection to the server
- Signal Quality
- Network Bandwidth
- Device configuration

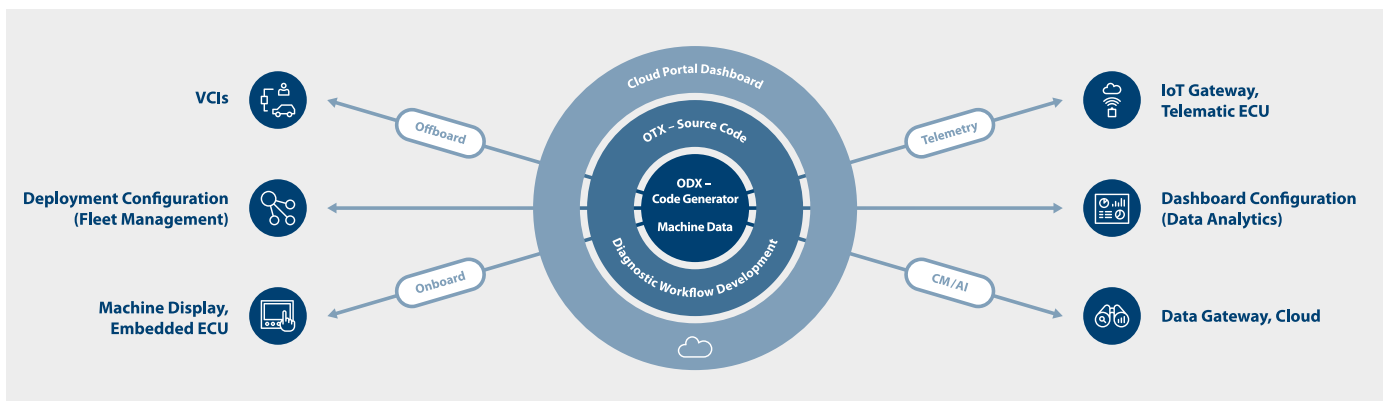
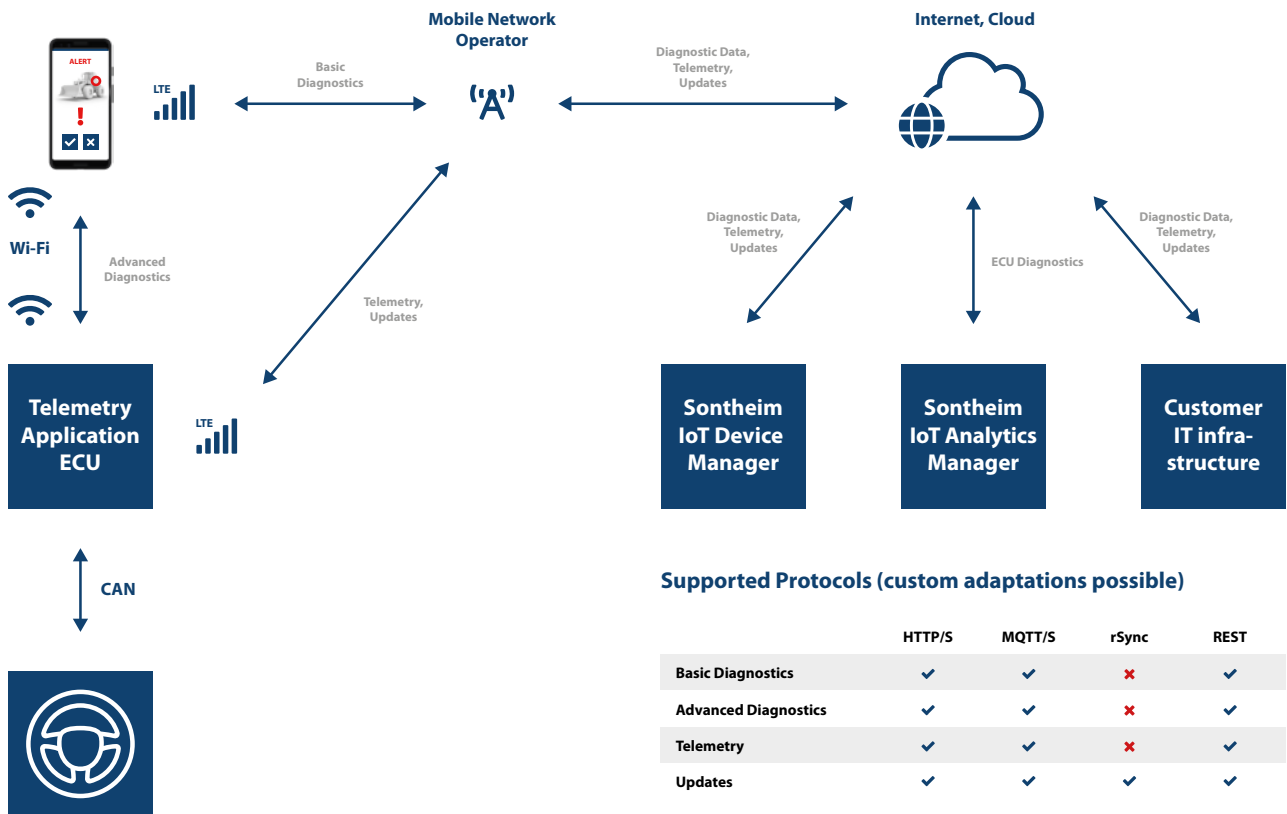

The IoT Device Manager can be hosted on a server on the Sonheim side or seamlessly integrated into an existing customer infrastructure. Secure data transfer is ensured thanks to SSL/TLS certification and can even be extended according to individual customer requirements. The IoT Device Manager can be branded OEM-specific. This allows the user to create different user levels, for viewing with different rights or for easy integration of sub supplier views.

Order information

V940871100

IoT Device Manager



IoT Analytics Manager

Cloud-based platform for data visualization and analysis

Key Features



Analysis and evaluation charts



Storage and visualization of device and vehicle data



Drag and drop functionality



Live data monitoring



Configurable dashboards, widgets and histograms



Individual configuration

The IoT Analytics Manager is a cloud-based tool for storing and visualizing your operational data (Big Data). OEM data can be analyzed and evaluated in various configurable dashboards, widgets and histograms. The amount of data and data traffic can be individually configured for different use cases. In addition, live data integration for real-time monitoring is possible, which can be individually configured by the customer.

The IoT Analytics Manager can be hosted on a server on the Sontheim side or seamlessly integrated into an existing customer infrastructure. Secure data transfer is ensured thanks to SSL/TLS certification and can even be extended according to individual customer requirements. IoT Analytics Manager can be branded OEM-specific. This allows the user to create different user levels, for viewing with different rights or for easy integration of sub supplier views.

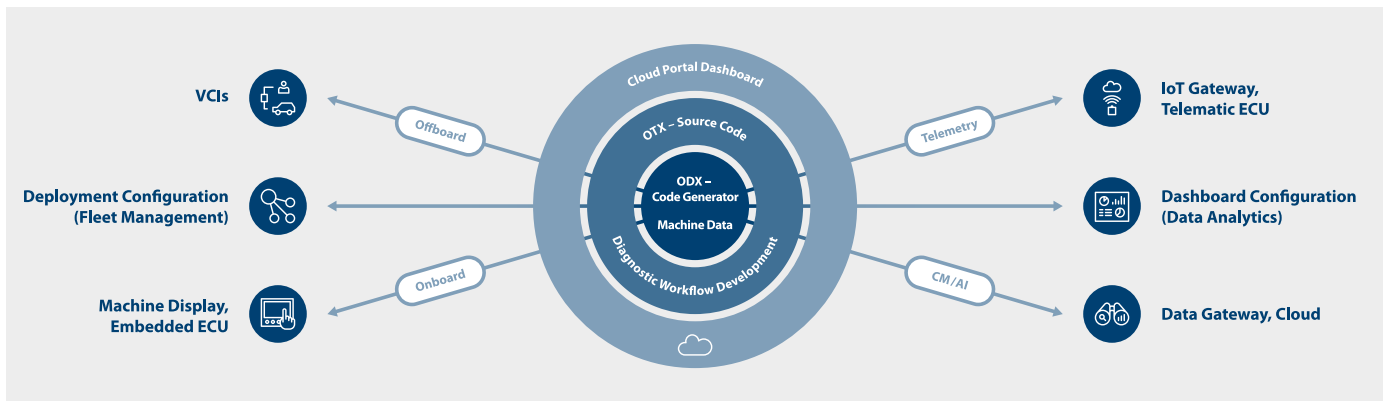
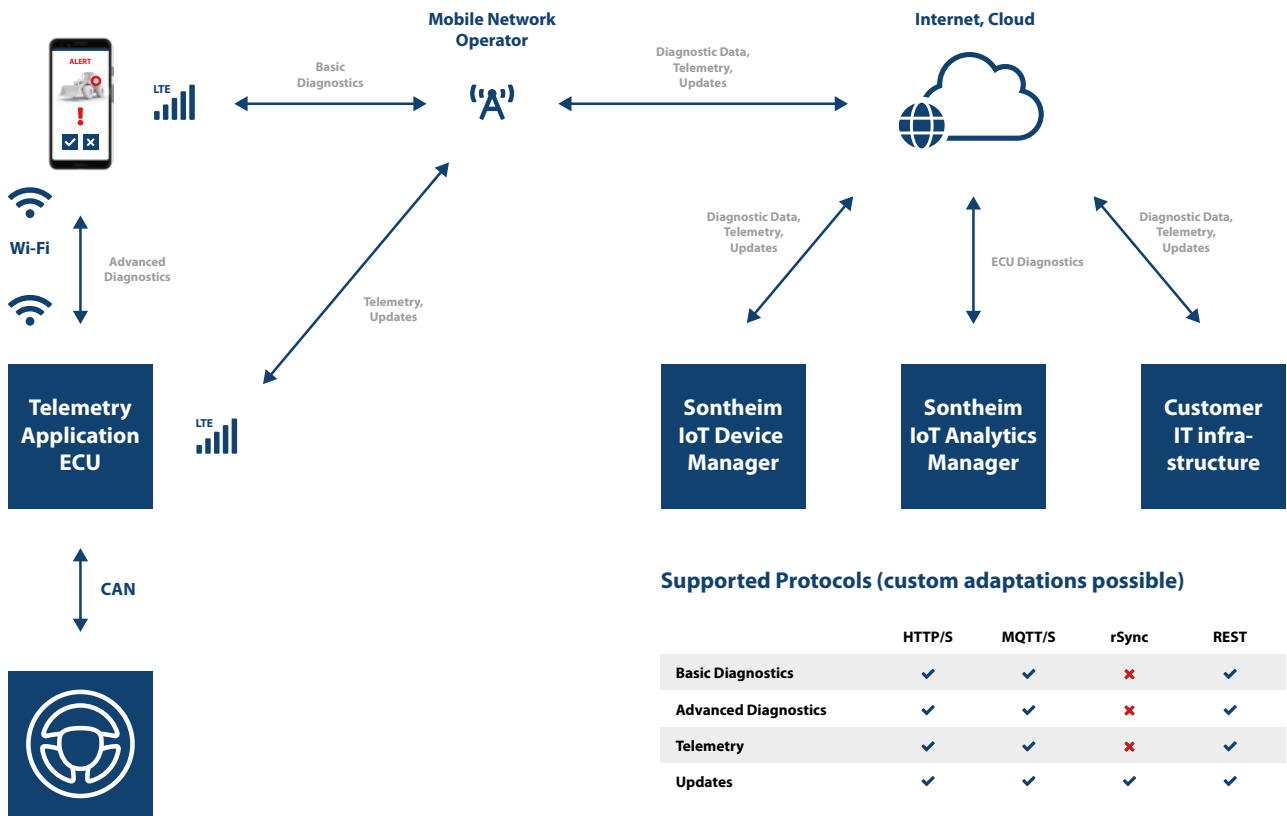

Order information

V940871200

IoT Analytics Manager



IoT Fleet Management

Cloud-based platform for data visualization and analysis

Key Features

tbd



Analysis and evaluation charts



Storage and visualization of device and vehicle data



Drag and drop functionality



Live data monitoring



Configurable dashboards, widgets and histograms



Individual configuration

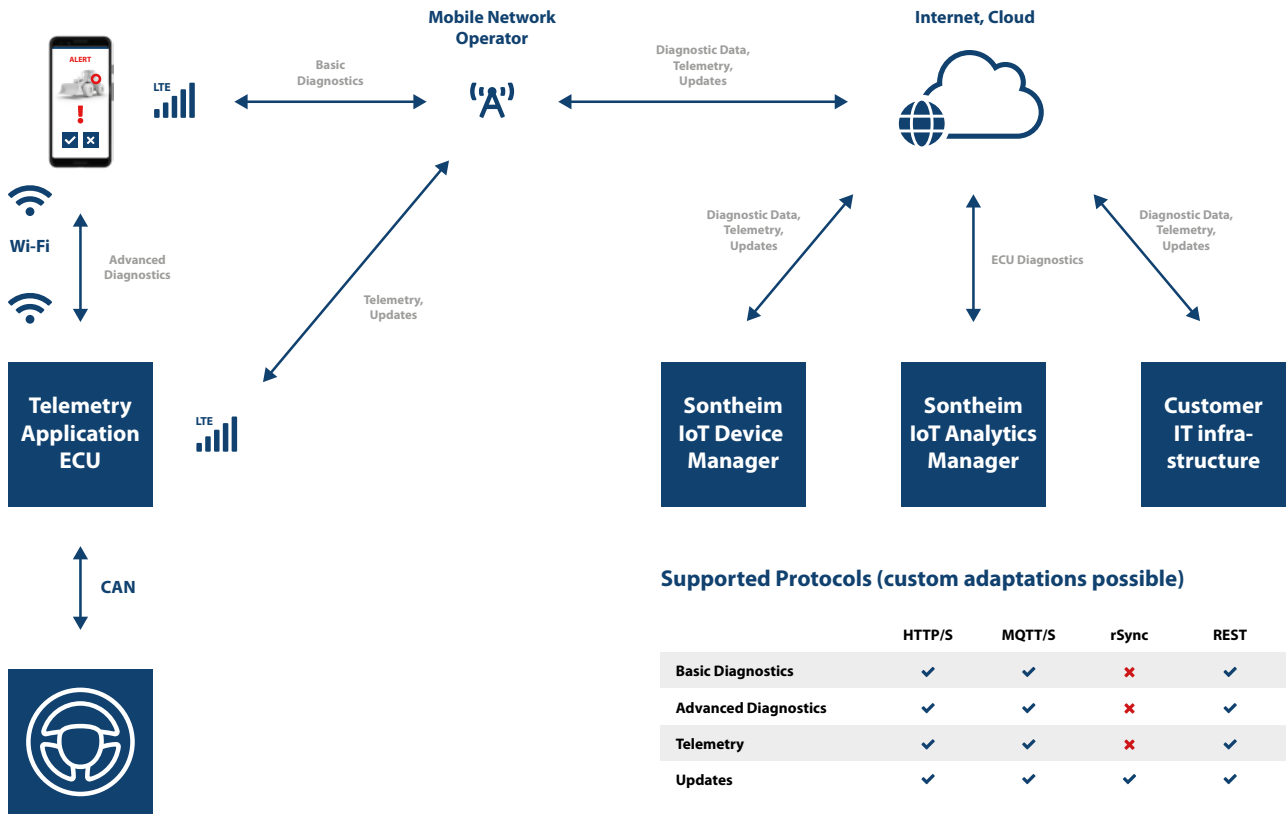

Supported Protocols (custom adaptations possible)

	HTTP/S	MQTT/S	rSync	REST
Basic Diagnostics	✓	✓	✗	✓
Advanced Diagnostics	✓	✓	✗	✓
Telemetry	✓	✓	✗	✓
Updates	✓	✓	✓	✓

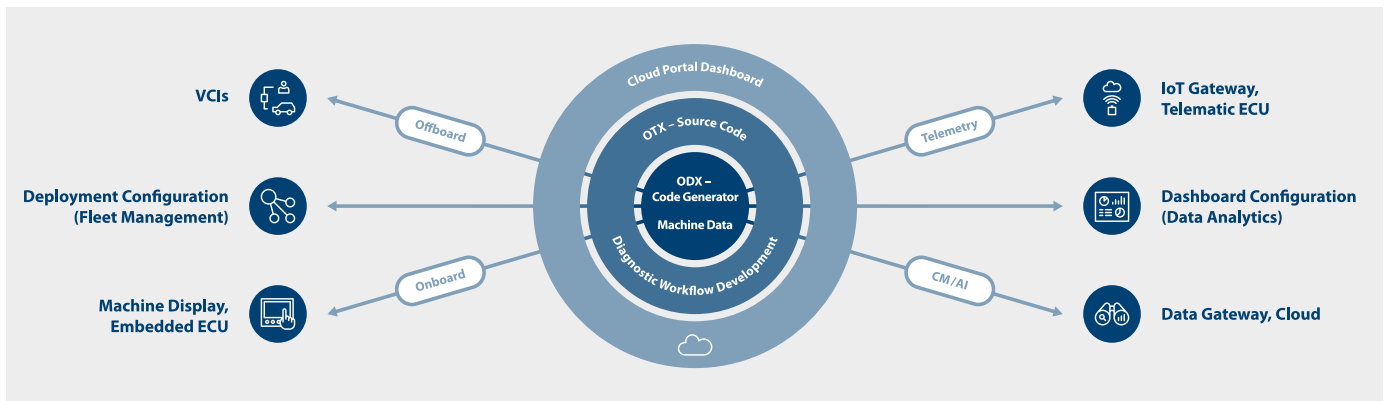

Order information

V940871200	IoT Analytics Manager
------------	-----------------------



Automation



Industrial Automation



Diagnostics



Connectivity



We automate and digitize industrial plants and machines and enable applications for Industry 4.0. Our system solutions enable OEMs to configure, parameterize and control their fieldbus network and to operate an effective analysis and evaluation of the machine status. We have many years of know-how in the field of industrial communication and offer solutions for CAN, CANopen, EtherCAT, Ethernet, PROFIBUS, PROFINET and other fieldbuses.

Benefit from integrated solutions for the automation of your plants. In the field of process automation, we have control solutions, such as industrial PCs, embedded PCs up to programmable logic controllers (PLC) with CODESYS and robust terminal and panel PC solutions. Extremely high-performance IO modules allow a tailor-made design for the most diverse fieldbus networks. Close and flexible data communication ensures an efficient and future-proof system.

Industrial Automation

**Controls, IO Modules, Computer-on-Modules, Drive Technologie,
Printing Technologie**

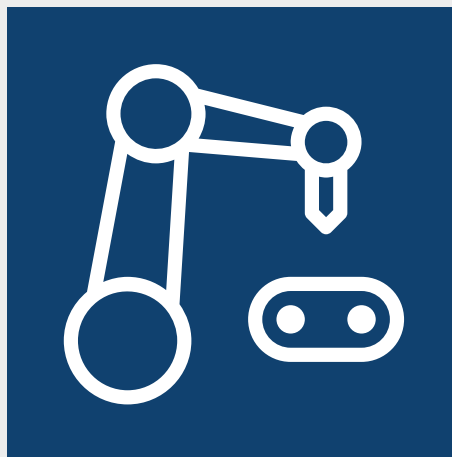













eControl micro II

Compact and powerful PLC with scalable CPU and high-resolution 7" touch display. IoT-ready and flexible use due to a high number of powerful and standardized interfaces.

Key Features

-  **OPC UA**
-  **CODESYS V3.5 acc. to IEC 61131-3**
-  **EtherCAT acc. to IEC 61131-3**
-  **CAN acc. to ISO 11898**
-  **7" TFT display with capacitive touch**
-  **WLAN optional**
-  **Bluetooth optional**
-  **CE certified**

At a glance

Equipped with an OPC UA server the use for IoT applications is possible independent of manufacturer, platform and fieldbus, making the controller universally usable. The PLC has a scalable CPU that has been specially optimized for CODESYS target and web visualizations. A capacitive touch display makes operation user-friendly through high accuracy and multi-touch capability. A variety of interfaces – such as Ethernet, Bluetooth, WLAN, USB, CAN, EtherCAT and digital In- and Outputs – complete the package.

Benefits

- Compact, powerful and scalable
- Fast and easy integration of IoT applications
- User-friendly and standardized
- High functionality due to OPC UA and CODESYS
- Manufacturer-independent software management to reduce maintenance efforts
- Variety of interfaces for a wide range of automation applications

Technical data

CPU	Single Core with 1.0 GHz Optional: Dual and Quad Cortex-A9 (1.2 GHz)
RAM	up to 1 GB
Memory	4 GB
Expandable memory	SD card up to 64 GB
TFT display	7"
Resolution	1024×600
Touch	capacitive
Ethernet	10/100 Mbit/s
USB	2× USB 2.0
CAN	1× CAN interface acc. to ISO 11898, galv. isolated
EtherCAT	1× RJ45
Serial interface	1× RS 232
Digital input (optional)	4× DI, 24 V, max. input current 10 mA
Digital output (optional)	4× DO, 24 V, max. output current 1 A
Real time clock	integrated (buffered)
Protection class (front)	IP54
Protection class (back)	IP20
Dimensions	220 mm × 280 mm × 10 mm (without plug)
Storage temperature	0 °C up to +60 °C
Operating temperature	+5 °C up to +50 °C
Temperature sensor	integrated
Humidity	5 % up to 95 % non-condensing
Power supply	24 V DC ±20 %
Operating system	Linux

Pin assignment



RJ 45 Ethernet

1	LAN/EtherCAT_TX+
2	LAN/EtherCAT_TX-
3	LAN/EtherCAT_RX+
4	-
5	-
6	LAN/EtherCAT_RX-
7	-
8	-



CAN

1	CAN L (high)
2	CAN H (low)
3	CAN GND
4	-
5	-
6	-
7	CAN GND
8	-



IO clamp (optional)

1	24V_I0
2	0V_I0
3	DI1
4	DI2
5	DI3
6	DI4
7	DO1
8	DO2
9	DO3
10	DO4



RS232

1	-
2	RxD
3	TxD
4	-
5	-
6	-
7	-
8	-
9	GND



USB

1	USB 5V
2	USB D-
3	USB D+
4	USB 0V



Power Supply

1	24V
2	0V
3	GND

Application example automation

IoT applications can be implemented with the state-of-the-art controller independently of the manufacturer and thus easily. The integration of OPC UA and CODESYS, among others, makes this possible.

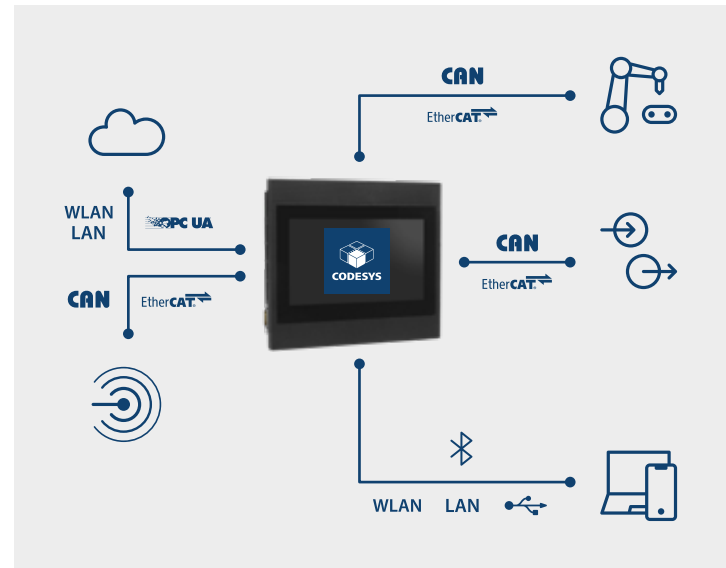

Order information

V966372000

eControl micro II



eControl mIO

The eControl mIO convinces as an all-round package with numerous communication interfaces. Equipped with the PLC, a large number of small machines do not require any further IO modules. It provides you with targeted and cost-effective support for your control tasks – for example, for controlling stepper motors.

Key Features



7" touch display



1× Ethernet interface



Up to 24 IOs



2× stepper interface



Microcontroller ARM Cortex-A9



Integrated microSD slot up to 64 GB



Programming in Qt 5.11.3



Modularity and housing choice



1× CAN interface acc. to ISO 11898 (opt.)

At a glance

The system is equipped with a wide range of interfaces – including Ethernet, e.g. for connection to a host system. The interface package is rounded off by USB, digital and analog inputs and outputs, interfaces for temperature sensors and stepper motors. In addition, there is the option of WLAN, Bluetooth for wireless data transmission and CAN for universal use. The PLC has a powerful CPU and is programmed with the Qt development framework. A capacitive touch display makes operation user-friendly through high accuracy and multi-touch capability.

Benefits

- Modular through SMARC architecture
- Application-friendly and standardized
- High potential for cost and cabling savings
- Loaded with interfaces for a wide range of automation applications
- Equipment options WLAN, Bluetooth, CAN
- Aluminium housing or simple mounting option

Technical Data

CPU	Single core with 1 GHz
RAM	up to 512 MB
Memory	4 GB
Expandable memory	microSD card up to 64 GB
TFT display	7"
Resolution	1024×600
Touch	capacitive
Ethernet	10/100 Mbit/s
USB	2× USB 2.0
CAN (optional)	1× CAN interface acc. to ISO 11898, galv. isolated
Dimensions (l×w×h)	182 mm × 117.5 mm × 8 mm
Storage temperature	0°C up to +60°C
Operating temperature	5°C up to +50°C
Humidity	5% up to 95%, non-condensing
Real-time-clock	integrated (buffered)
Protection class (front)	IP67
Power supply	24 V DC ±20%
Operating system	Linux

IOs

Digital inputs	4× DI, max. input current 10 mA
Digital outputs	8× DO, max. output current 500 mA
Analog inputs	4× AI (2× 0–10 V, 2× 0–20 mA), 12 bit
Analog outputs	4× AO (2× 0–10 V, 2× 0–20 mA), 10 bit
Stepper motor	2× interface, galv. isolated
Temperature sensor	2× PT100 input

Product labeling

CE label	EN 61000-6-2 Electromagnetic compatibility (EMV) immunity EN 61000-6-4 Electromagnetic compatibility (EMV) emission
----------	------------------------------------------------------------------------------------------------------------------------

Development framework Qt and operating system Linux

The controller is programmed with the platform-independent development framework Qt 5.11.3. It is developed in C++ and libraries for a graphical user interface (GUI) are available. The allocation of a control library enables a very fast integration of stepper motors. The operating system used is Linux.

Application example automation

Control, operate and display – eControl mIO is the versatile controller with various fieldbus interfaces, IOs and motor interfaces for easy realization of automation requirements.

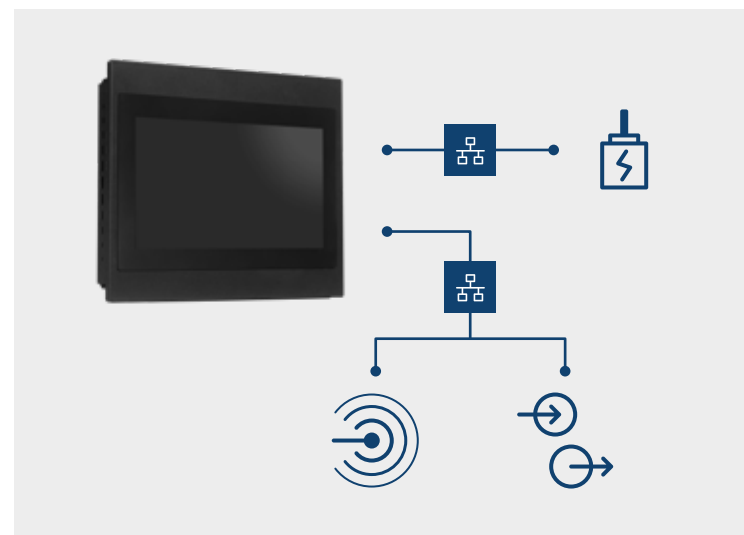

Pin assignment



RJ 45 Ethernet

1	LAN_TX+
2	LAN_TX-
3	LAN_RX+
4	–
5	–
6	LAN_RX-
7	–
8	–



CAN (optional)

1	CAN L (high)
2	CAN H (low)
3	CAN GND
4	–
5	–
6	–
7	CAN GND
8	–



USB

1	USB 5V
2	USB D-
3	USB D+
4	USB 0v



Stepper Unit

1	Stepper 1/2 – winding 1+
2	Stepper 1/2 – winding 1-
3	Stepper 1/2 – winding 2+
4	Stepper 1/2 – winding 2-



Order information

V966370250

eControl mIO



eControl mIO xt

Equipped with a variety of interfaces, the control with 10.1" touch display can be used for a wide range of automation applications. An integrated motion sensor makes it an energy miracle.

Key Features



Motion sensor



Up to 66 IOs



MDT 2.0 integrated



OPC UA Server & Client



2× CAN acc. to ISO 11898, galv. isolated



EtherCAT acc. to IEC 61158



2× Ethernet (100 Mbit/s, 1000 Mbit/s)



Linux operating system

Unbeatable Team with MDT 2.0

The Modular Diagnostic Toolchain with OPC UA can be integrated on the PLC, creating the perfect state-of-the-art solution for your Industrie 4.0 applications. The new MDT® 2.0 provides a standardized tool to access data of the machine. It enables the standardization of data description (ODX), programming (OTX) and data sharing & provision (OPC UA). It is the perfect basis for innovative machine park monitoring. Combined with the eControl mIO xt, Sontheim creates the all-round package: smooth machine control, standardized diagnostics and simple cloud connection.

Variety of Interfaces

The eControl mIO xt is equipped with a number of interfaces. In addition to a motion sensor, the controller also has each two CAN, Ethernet, and USB connections as well as up to six temperature sensor inputs. One of the two Ethernet interfaces is EtherCAT and OPC UA capable. An interface board carries the digital inputs and outputs, as well as the majority of analog interfaces. All connectors are accessible from the rear side of the device.

Technical Data

Hardware	
CPU	IMX 6 Quad Core
Co-Processors	2x ATXMEGA, 1x LPC433x
RAM	1 GB LPDDR2
Speicher	4 GB
Display	10.1" RGB 1280 (W) x3(RGB) x800(H) / 500 cd / IPS / anti-glare
Touch	resistive
LEDs	2 LEDs for display of power supply and CAN communication
Dimensions (l×w×h)	300 mm × 200 mm × 55 mm
Operating temperature	-20 °C up to +60 °C
Lagertemperatur	-30 °C up to +85 °C
Real-Time-Clock	2 weeks buffered via supercaps
Weight	approx. 2.1 kg
Protection class (front)	IP65
Protection class (back)	IP20
Power supply	24 V DC ±15 %

Motion sensor

The pyroelectric sensor, or PIR sensor for short (Passive Infrared Sensor), reacts to movement and switches the display and backlight on as soon as movement is registered. This function is used to turn off the display and backlight when the device is not being operated and saves energy. The sensor is seamlessly integrated into the front panel.





EtherCAT and CAN Interfaces

Via the CAN and Ethernet interfaces you can configure the module for a CAN or EtherCAT network. As interfaces for data exchange it has two RJ45 sockets and one D-Sub9 CAN interface, which allows an easy connection with other modules.

Interfaces	
Motion sensor	1x PIR Sensor
CAN	2x CAN acc. to ISO 11898, galv. isolated
USB	2x USB 2.0
Ethernet	2x (1x 100 Mbit/s; EtherCAT, OPC UA; 1x 1000 Mbit/s)
Digital inputs	24x DI (3x8), 24 V DC
Digital outputs	24x DO (3x8), 24 V DC
Analog inputs (optional)	10x AI, 16-bit, Output voltage range: 0 up to 10 V Output current range: 0 up to 20 mA
Analog outputs (optional)	4x AO, 16-bit Output voltage range: 0 up to 10 V
Temperature sensor inputs	4x 24-bit, optional up to 6x
SD card slot	1x

Operating system	
Operating system	Linux
Runtime	opt.: MDT 2.0 embedded

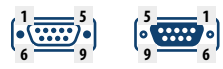
Pin assignment

	
RJ 45 Ethernet 100 Mbit/s	RJ 45 Ethernet 1000 Mbit/s
1 LAN/EtherCAT_TX+	1 D1+
2 LAN/EtherCAT_TX-	2 D1-
3 LAN/EtherCAT_RX+	3 D2+
4 -	4 D3+
5 -	5 D3-
6 LAN/EtherCAT_RX-	6 D2-
7 -	7 D4+
8 -	8 D4-
	
CAN D-Sub9	USB
2 CAN L (low)	1 USB 5V
3 CAN GND	2 USB D-
5 CAN GND	3 USB D+
7 CAN H (high)	4 USB 0V

Order information

V966373700	eControl mIO xt
V966373611	Clamp block



ePC

ePC is a modular embedded platform for being used in all areas of the automation sector. The design principle of bus-coupling devices allows extensions while the basic system remains untouched.

Key Features



Atom-CPU with passive cooling



Numerous interfaces like CAN, Ethernet, IOs, CFast, DVI and USB



Software tools for all tasks around the CAN bus



Link2Go: Extension modules can be attached without adapting the ePC like fieldbus couplers



IP20 full metal housing for optimum EMC protection

Main technical advantages

There are several different processor types of the Atom family available. The chipset is known for a high energy efficiency and little heat waste. It has 1 to 2 GB RAM on-board for small to complex operations. Instead of a usual HDD the ePC uses CFast which is the faster successor of Compact Flash – the system can also be booted over this interface. The advantage is a data transfer speed of up to 3 Gbit/s. Of course, all CFast cards can be purchased via Sontheim. A full metal housing together with the specific memory and CPU provides optimal EMC-capabilities and passive cooling even at high temperatures.

Link2Go – Expand your PC!

Modern automation applications require efficiency and the flexibility to adapt to changing environments in an individually matching way. Link2Go is a concept of adding extension modules quickly and conveniently to the ePC. However, the basic unit remains as it is and the user can change the modules later on if necessary. The range of the planned extensions varies from touch displays and bus couplers to hard disk drives and serial interfaces. There could even customer-specific modules be created. Link2Go – your personal embedded solution for the price of standard components.

Technical Data

Chipset	Freely selectable Atom-Chipsets, e.g. 1.3 GHz / 1 GB RAM CPU boards are exchangeable, new CPU platforms thus retrofittable
RAM	1–2 GB, optional separate process data storage (Retain storage)
HDD	Slot for CFast-Card or Link2Go module, bootable
CAN	1× CAN interface acc. to ISO 11898, galv. isolated
LAN	2× Gigabit LAN (one interface is EtherCAT-capable)
WLAN	optional
Digital Inputs	4× DI, acc. to IEC 61131-2, separate supply
Digital Outputs	4× DO, acc. to IEC 61131-2, separate supply
USB	4× USB 2.0
DVI-D	1×
Connection of external peripheral components	Mouse, keyboard and other peripherals via USB 2.0 Visualization via DVI or via Link2Go module
LEDs	Power, HDD and CAN
Dimensions (l×w×h)	120 mm × 115 mm × 111 mm
Storage temperature	–20 °C up to +65 °C
Operating temperature	0 °C up to +60 °C; extended temperature range with –40 °C up to +85 °C
Humidity	5 % – 95 % non-condensing
Protection class	IP20
Power supply	24 V DC ±20 %
Total current	max. 1.2 A

Interfaces

The ePC incorporates many interfaces for a maximum of flexibility already in its basic version without extensions (Link2Go). These includes CAN, Ethernet (EtherCAT capable), digital inputs and outputs, DVI and USB. In the basic configuration tasks as PLC, CAN bus master or slave, signal processing center and many more applications are possible. An integrated CFast interface like an USB stick thought for data logging and even booting the system.

Order information

V971011000

ePC

Pin assignment



DVI-D

01	TDMS-data 2–
02	TDMS-data 2+
03	Shield TDMS-data 2.4
04	TDMS-data 4–
05	TDMS-data 4+
06	DDC frequency
07	DDC frequency
08	Analog: V-Sync
09	TDMS-data 1–
17	TDMS-data 0–
18	TDMS-data 0+
19	Shield TDMS-data 0.5
20	TDMS-data 5–
21	TDMS-data 5+
22	Shield TDMS-frequency
23	TDMS-data +
24	TDMS-data–
C1	NC
C2	NC
C3	NC
C4	NC
C5	NC



Digital IOs

1	24 V power supply
2	Digital input 0
3	Digital input 1
4	Digital input 2
5	Digital input 3
6	GND
7	Digital output 0
8	Digital output 1
9	Digital output 2
10	Digital output 3



RJ 45

1	TXD+
2	TXD–
3	RXD+
4	BIAS1
5	BIAS1
6	RXD–
7	BIAS2
8	BIAS2



CAN

1	–
2	CAN low
3	CAN GND
4	–
5	–
6	–
7	CAN high
8	–
9	–



USB

1	VCC (VBUS)
2	– Data
3	+ Data
4	GND (Ground)

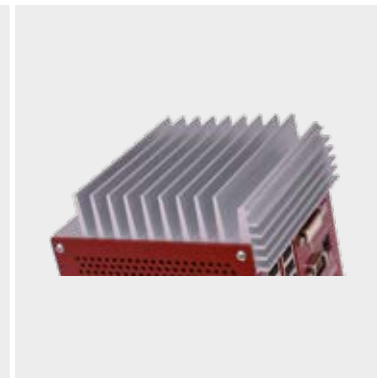



IPC-4

The IPC clearly sets itself apart from the competition with its scalable scope of performance. Both computing power and the type and number of interfaces offer many possibilities for individual adaptation.

Key Features

- ✓ Significantly increased performance
- ✓ Scalable power
- ✓ Additional interfaces easily integrated
- ✓ All interfaces accessible from the front
- ✓ Very good performance even in harsh environments
- ✓ Suitable for industrial use due to integrated power supply and fan

In its latest generation the IPC-4 combines the Sontheim know-how in state-of-the-art technology and integrated solutions. It is perfectly suited to all tasks in the automation and automotive industry. Due to its scaleable CPU, RAM, HDD and interfaces, you will have a PC that fits your application in every aspect. Both computing performance and number/type of interfaces offer various different versions. This creates a maximum of mudalirty and scalability. Of course, the housing is suitable for top hat rail mounting and allows access to all interfaces at the front cover, enabling comfortable handling and well-arranged cabling.

Scalable performance

The clock frequencies currently range from 600 MHz with an Intel Celeron M to 2x 2.16 GHz with an Intel Core 2 Duo. Depending on the board type, up to 4 GB DDR RAM is used; thus, even computationally intensive tasks are possible without difficulty. An Intel Atom processor can be used as a power-saving variant.

Made for rough environments

The SATA HDDs used are approved for 24/7 operations. We are happy to switch to industrial temperature ranges for you. It is also possible to have devices with no rotating parts like Solid State Disks (SSD) which will guarantee you highest process reliability even in very rough environments.

Many interfaces in a compact design

The IPC-4 has six USB 2.0 ports, two Gigabit Ethernet (10/100/1000 BaseT), two serial interfaces as well as a DVI and a VGA connector. Additionally, there is a CF slot implemented. You will note that the device facilitates a clear arrangement of cabling with all interfaces being allocated at the front cover. The side parts are reserved for cooling fans and heat exhaust. Little cooling fins add up to controlling any heat.

Left side = standard, right side = flexible

Probably the most important advantage of the IPC-4 is its modular design that is suited for customer-specific extensions. PCI104 and PC104+ cards are up to most individual requirements like CAN, FireWire, digital and analog inputs and outputs, Framegrabber and many more functions.

32 KB battery buffered ZERO-RAM

The IPC will save runtime variables in this RAM memory for you in order to keep them in a case of a loss of power.

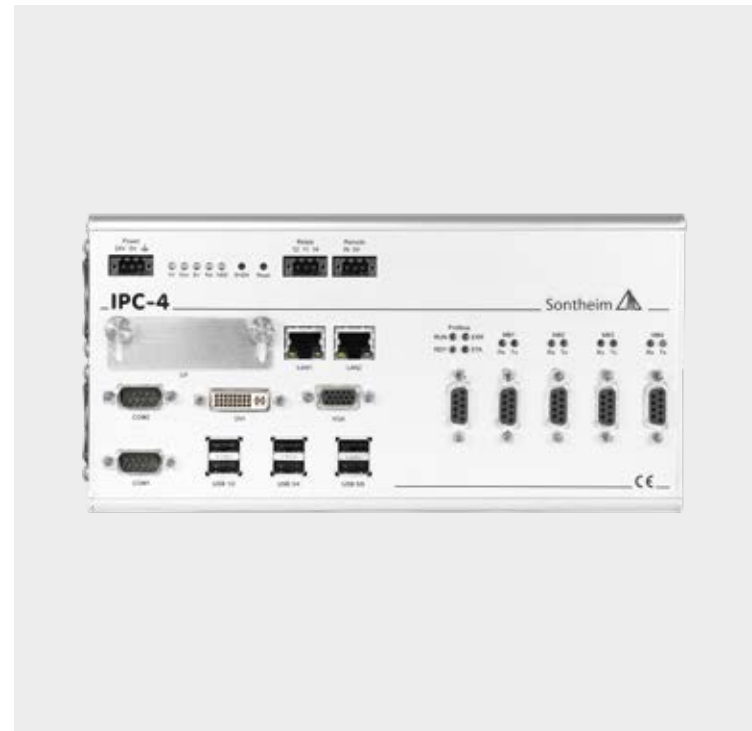

Technical Data

CPU Versions	600 MHz	1.5 GHz	2x 2.16 GHz
CPU	Intel Celeron M 600 MHz, ULV, 512 KB Cache, FSB 400 MHz	Intel Celeron M 370 1.5 GHz, 1 MB Cache, FSB 400 MHz	Intel Core 2 Duo T7400, 2.6 GHz, (4M Cache, 667 MHz FSB, 65 nm), socket mPGA479M
RAM	SO-DIMM DDR2 DDR533/ PC4200 up to 2 GB		2 socket, SO-DIMM DDR2 667/PC5300 up to 4 GB, 3 GB usable
Chipset	Graphics & memory controller hub: Intel 915GME IO controller hub: Intel 82801FBM (ICH6-M)		Graphics & memory controller hub: Intel 945GME IO controller hub: Intel 82801GHM (ICH7M-DH)
VGA resolution	Up to 2048x1536 (75 Hz)		

Interfaces	
Power/Watchdog	1x power supply, 1x relay, 1x remote
VGA	Depending on COM Express module (see CPU types)
DVI	1x DVI (resolution 640x480 up to 1600x1200, depending on display)
CF	CF-card acc. to specification 4.1 (CF UDMA Mode 0–4, PIO Mode 0–6)
USB Flash memory	Internal slot for Disk-on-Module flash memory via USB 2.0
Ethernet	LAN1 Gigabit Ethernet, Realtek RTL8111 10/100/1000 BaseT; LAN2 Intel 82573L 10/100/1000 BaseT interface, via PCIe/express lane
USB	6x USB 1.1/2.0 up to 480 Mbit/s, power output 500 mA each
Serial interfaces	2x standard RS232 (with all handshake-signals), galvanic isolation optional (up to 2 kV)
PCI104 or PCI04+	2x PCI104 or PCI04+ slots for customer-specific interfaces
Optional PCI04+ cards	CAN Bus FireWire Serial interfaces (RS232/RS485/RS422) PROFIBUS Framegrabber Digital/analog inputs and outputs Customer-specific functions

Hardware	
Status LEDs * please see the manual for further information	5 V – LED illuminated when connected to power supply Device ready for start/started* Run – shows operating status of the IPC-4* Err – Errors cause the error LED to blink* Rel – LED is illuminated when relay adduct, turns off at dropout (Pin 12, 11 and 14) * HDD – shows the status of the internal HDD and the CF-card*
Buttons	SHDN – Start resp. automatic shutdown and power off, as long as ACPI is activated. Reset – Causes a warm boot
HDD	2.5" HDD (SATA or IDE up to 9.5 mm height)
Support of periphery components via USB	CD-/DVD-ROM; CD-/DVD-RW; HDDs, USB-sticks, mouse and keyboard, other peripheral components
Certificates	EMC acc. to CE with EN 61000-6-4:2007, EN 55022:2006, EN 61000-6-2:2005, EN 61000-4-2:1995 + A1:1998 + A2:2001, EN 61000-4-3:2006, EN 61000-4-4:2004, EN 61000-4-5:2006, EN 61000-4-6:1996 + A1:2001 GL (on inquiry)
Dimensions (l×w×h)	244 mm (+10 mm minimum space to the left and right) × 121 mm × 95 mm (without connectors)
Housing	Compact aluminium case with integrated top hat rail (TS35)
Storage temperature	–20 °C up to +65 °C
Operating temperature	0 °C up to +45 °C, optional –20 °C to +65 °C (with automotive HDD or Industrial CF-card and active cooling)
Humidity	5 % – 95 % non-condensing
Power supply	24 V DC ± 20% (for standard versions) 24 V DC –25 % / +30 % (for GL-versions, German Lloyd) Power supply for automotive area available on enquiry
Power consumption at 24 V DC (without external periphery)	Max. power consumption 1.0 to 2.0 Start-up current 2.5 to 4.5 A
Power adaptor (integrated)	ATX – compatible, Wake-up via LAN supported

Pin assignment



RJ 45

1	TXD+
2	TXD-
3	RXD+
4	BIAS1
5	BIAS1
6	RXD-
7	BIAS2
8	BIAS2



VGA

1	Red
2	Green
3	Blue
13	HSync
14	VSync
12	DDC-Data
15	DDC-clock
9	5V
5-8, 10	GND
4, 11	NC



COM1

1	DCD
2	RXD
3	TXD
4	DTR
5	GND
6	DSR
7	RTS
8	CTS
9	RI



USB

1	VCC (VBUS)
2	- Data
3	+ Data
4	GND (Ground)



DVI

01	TDMS-data 2-
02	TDMS-data 2+
03	Shield TDMS-data 2.4
04	TDMS-data 4-
05	TDMS-data 4+
06	DDC frequency
07	DDC frequency
08	Analog: V-Sync
09	TDMS-data 1-
17	TDMS-data 0-
18	TDMS-data 0+
19	Shield TDMS-data 0.5
20	TDMS-data 5-
21	TDMS-data 5+
22	Shield TDMS-frequency
23	TDMS-data +
24	TDMS-data -
C1	Analog: red
C2	Analog: green
C3	Analog: blue
C4	Analog: H-Sync
C5	Analog: Mass

Order information

V969000600	IPC-4; 600 MHz Intel Celeron M
V969001500	IPC-4; 1.5 GHz Intel Celeron M 370
V969002100	IPC-4; 2x 2.16 GHz Intel Core2Duo T7400
V990230000	IPC-4 Customizing



Panel-PC 8000

Panel-PC 8000 combines the flexibility of our industrial PCs with a rigid control and display panel. Due to its robust design, it is highly suited for machine control and HMI purposes.

Key Features



Robust terminal for the control of machines



Powerful and energy-saving Intel Atom processor



Expansion slots for individual adaption



Mounting arm attachment for flexible placement

Equipment and display

A 1.1 GHz Atom processor provides computing power at low energy consumption. There are 512 MB RAM available as well as an integrated SD-card with 2 GB for applications. The terminal contains a control and display panel for visualizing data and operating software tools. Consequently, Panel-PC 8000 is an ideal HMI.

Interfaces

The terminal provides two CAN channels with M12 plugs. External periphery like mouse or keyboard are simply connected via USB 2.0. It provides an ethernet port via M12 with a bandwidth of 100 Mbit/s.

Technical Data

CPU	Intel Atom CPU 1.1 GHz
RAM	512 MB
Memory	Internal SSD ATA SolidStateDrive-Flash, 512 MB Internal SD-Slot with integrated 2 GB SD-card Other SD-cards available upon enquiry
CAN	2× CAN interface via 2× M12 connectors (2× female)
USB	2× USB 2.0, Type A
Ethernet	1× Ethernet, 100 Mbit/s, M12
Supported CAN interfaces	CANUSB, CANfox®, others upon enquiry
Display	7"
Resolution	800×480, 262 colors
Touch	resistive
Surface	Anti glare and wide view
Buttons/Front foil	19 buttons incl. keypad and navigation
LEDs	2 LEDs for monitoring current supply errors
Dimensions (l×w×h)	308 mm × 283 mm × 80 mm
Storage temperature	−10 °C up to +55 °C
Operating temperature	0 °C up to +45 °C
Weight	3.0 kg
Housing	Plastic housing with support arm mount
Rel. Humidity	5 % – 95 % non-condensing
Protection class	IP65
Supply voltage	24 V DC ±20 % via CAN-M12 interface

Pin assignment



USB

1	VCC (VBUS)
2	− Data
3	+ Data
4	GND (Ground)



CAN 1 with VCC

1	CAN GND
2	24 V ±20 % Supply voltage
3	0 V Supply voltage
4	CAN High
5	CAN Low



CAN 2

1	CAN GND
2	−
3	−
4	CAN H (high)
5	CAN L (low)



Ethernet

1	Tx+ (transmit data +)
2	Rx+ (receive data +)
3	Tx− (transmit data −)
4	Rx− (receive data −)
5	Connector thread is shield

Order information

V970001000	Panel-PC 8000
------------	---------------

Flexibility via PCI extensions

The two extension slots enable an integration of additional extensions. There are many different versions of extension cards available, much like our IPC-4: CAN, FireWire, digital and analog inputs and outputs, PROFI-BUS and many more functions can be integrated for a customer-specific solution. Panel-PC 8000 can therefore be used as a standard-HMI or as an individually tailored control system.

Robust design

HMI in production facilities might be exposed to temperature changes, splash water and mechanical forces. Panel-PC 8000 is designed to withstand such effects with the help of a robust design. No water can enter the housing. All connectors have an inward barrier. The foil keyboard with extra large buttons is made for bigger gloves. Finally, a wall mount arm can be used for having the terminal mounted outside of a control cabinet.





Digital Remote IO-Modules

DIO32 is a digital 24V (opt. 12V) input and output module with 16 channels each. It is optimally suited for the use in CAN networks. The device possesses the shortest conversion times and a high process reliability. That makes it the best choice for continuous operation in complex machine networks.

Key Features



Safety features for high running safety



Galv. isolated CAN interface acc. to ISO 11898



Easy access to all interfaces



Own intelligence for complex CAN networks



All clamps pluggable and lockable



Signal delay of less than 400 µs



Galv. isolated inputs



Compact aluminium housing with IP20 and integrated top hat rail mounting

Overview of interfaces

- 16 digital inputs
- 16 digital outputs

Housing

The compact housing is made of aluminium. It contains a top hat rail mount and a front cover with all interfaces for better overview in the control cabinet. The technician will note the convenience while working at the bus cabling.

Clamps and cabling

The Remote-IO series uses 3-wire cabling for direct connection to sensors and actors, supplying them with power. In order to reduce the danger of false-wire harnessing the 3-wire clamps are colored. If you wish to see the status of each channel, we can deliver the modules with LED-clamps.

LEDs and switches

All inputs and outputs can be monitored with the help of LEDs at the clamps. In addition to that, you can configure the baud rate and module address with HEX switches at the front cover – easy and comfortable.

Signal processing

Besides its inputs and outputs the DIO32 offers a powerful microcontroller that handles data acquisition of sensors, control of actors and the processing of any CAN data. An important safety function is the DIO32's guarding capability which is fully integrated into the IO for network surveillance. Furthermore, there is a relay contact (changeover) as an additional safety measure. If there is an absence of guarding by the master registered, the module immediately goes into STOP-mode.

CAN interface

The integrated CAN interface is designed in accordance to DS301 and 401 for a flexible use in different places and tasks in the CAN bus network. All Sontheim CAN interfaces comply to ISO 11898.

Power supply

The DIO32 needs a power supply with 24 V. Due to the polarity reversal protection the user is in no danger of damaging the module by reversed power connection. Short surge peaks are also eliminated by an EMI wiring for the control section.

Highside and Lowside switch

All digital outputs can be fitted with a Highside or Lowside switch. Being Highside, the outputs toggle the supply voltage to load. Being Lowside, they toggle to ground.

DI32



DO32



DIO32



DI40



DIO40



DIO72



Technical Data

Hardware	DI32	DO32	DIO32	DI40	DIO40	DIO72
CPU	16-bit microcontroller					
CAN	Galvanically isolated acc. to ISO 11898, D-Sub9 plug male and female, bridged; Assignment acc. to DIN 41652					
CAN protocol	DS 301 and 401					
Number of modules/bus	127					
Setting	of module address via two HEX-switches of baud rate via HEX-switch					
Connection system	Spring connection clamping range 0.25 – 1.5 mm ² , solid wire "e", Fine wire "f" 0.25 – 1.5 mm ² , "f" with wire end ferrule, without plastic collar 0.25 – 1.5 mm ²					
Connection technology	Two-wire and three-wire connection, stripping length 10 mm					
Operating status	1× LED green for power supply (5V) 1× LED green for operation mode (Run) 1× LED red for error status (Err) 32× LED green for set inputs	1× LED green for power supply (5V) 1× LED green for operation mode (Run) 1× LED red for error status (Err) 32× LED green for set outputs (at the clamp)	1× LED green for power supply (5V) 1× LED green for operation mode (Run) 1× LED red for error status (Err) 16× LED green for set inputs 16× LED green for set outputs (at the clamp)	1× LED green for power supply (5V) 1× LED green for operation mode (Run) 1× LED red for error status (Err) 40× LED green for set inputs	1× LED green for power supply (5V) 1× LED green for operation mode (Run) 1× LED red for error status (Err) 32× LED green for set inputs 8× LED green for set outputs (at the clamp)	1× LED green for power supply (5V) 1× LED green for operation mode (Run) 1× LED red for error status (Err) 32× LED green for set inputs 40× LED green for set outputs (at the clamp)
Dimensions (l×w×h)	121 mm × 120 mm × 48 mm				241 mm × 120 mm × 48 mm	
Weight	600 g				800 g	
Protection class	IP 20, EMC requirements acc. to CE					
Storage temperature	–30 °C up to +70 °C					
Operating temperature	0 °C up to +60 °C					
Humidity	90 % non-condensing					
Power supply	24 V DC ±20 %					
All inputs/outputs active, incl. LEDs	540 mA	440 mA	500 mA	540 mA	500 mA	830 mA

Digital inputs	DI32	DO32	DIO32	DI40	DIO40	DIO72
Number of inputs	32	–	16	40	32	
Switching level "1"	+15.0 V up to +28.8 V DC	–	+15.0 V up to +28.8 V DC			
Switching level "0"	0.0 V up to +8.0 V DC	–	0.0 V up to +8.0 V DC			
Potential isolation	Optocoupler	–	Optocoupler			
Input current/input	11 mA	–	11 mA			
Sampling frequency (Fg)	2.5 kHz	–	2.5 kHz			
Signal delay	< 400 µs	–	< 400 µs			

Digital outputs	DI32	DO32	DIO32	DI40	DIO40	DIO72
Number of outputs	–	32	16	–	8	40
Power	–	24 V DC ±20 %		–	24 V DC ±20 %	
Circuit type	–	FET-Highside-Switch		–	FET-Highside-Switch	
Potential isolation	–	Optocoupler		–	Optocoupler	
Output current/output	–	1 A (short circuit proof)		–	1 A (short circuit proof)	
Total current of the Module	–	8 A		–	8 A	
Total current of the Module with blockwise supply	–	32 A	16 A	–	8 A	40 A
Switching frequency	–	1 kHz		–	1 kHz	
Freewheel diode	–	Yes, controlled inductors require external freewheel diodes		–	Yes, controlled inductors require external freewheel diodes	
Signal delay	–	< 100 µs		–	< 100 µs	
Relay contact (if module is active)	–	1× UM / 1 A		–	1× UM / 1 A	

Pin assignment

Clamp block

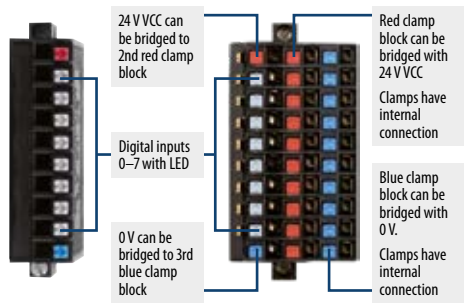

+	nc
1	Input 0 / Output 0
2	Input 1 / Output 1
3	Input 2 / Output 2
4	Input 3 / Output 3
5	Input 4 / Output 4
6	Input 5 / Output 5
7	Input 6 / Output 6
8	Input 7 / Output 7
-	GND 0 V



CAN D-Sub9

1	-
2	CAN low
3	CAN GND
4	-
5	-
6	-
7	CAN high
8	-
9	-



HEX-Switches module address

Minimum 01 HEX	1
Maximum 7F HEX	127



HEX-Switch baud rate

0	10
1	20
2	50
3	125
4	250
5	500
6	800
7	1000

Order information

V966117000	DI32_RM35 24 V IO
V966117400	DI32_RM35 12 V IO
V966127000	DO 32_RM35 24 V IO High-Side
V966127300	DO 32_RM35 12 V IO High-Side
V966127400	DO 32_RM35 12 V IO Low-Side
V966160000	DIO 32_RM35 24 V IO High-Side
V966160300	DIO 32_RM35 12 V IO High-Side
V966160400	DIO 32_RM35 12 V IO Low-Side
V966181000	DI40_RM35
V966180000	DIO40_RM35, 32x dig.In. & 8x dig. Out 24 V IO
V966170000	DIO 72_RM35 24 V IO High-Side
V966170300	DIO 72_RM35 12 V IO High-Side
V966170400	DIO 72_RM35 12 V IO Low-Side
V980109000	Weidmüller BL IO-30-pole with LED (not included in delivery)
V980109100	Weidmüller BL IO-30-pole without LED (not included in delivery)
V980109200	Weidmüller BL IO-10-pole with LED (not included in delivery)
V980109300	Weidmüller BL IO-10-pole without LED (not included in delivery)



Multi-IO

The CANopen module Multi-IO is a powerful device for handling digital and analog signals. It incorporates 56 channels of different communication channels. The device possesses the shortest conversion times and a high process reliability. That makes it the best choice for continuous operation in complex machine networks.

Key Features



Safety features for high running safety



Galv. isolated CAN interface acc. to ISO 11898



Easy access to all interfaces



Own intelligence for complex CAN networks



All clamps pluggable and lockable



Signal delay of less than 200 µs



Galv. isolated inputs



Compact aluminium housing with IP20 and integrated top hat rail mounting

Overview of interfaces

- 16 digital inputs
- 16 digital outputs
- 8 analog inputs
- 8 analog outputs
- four 24-bit encoder interfaces
- one CAN interface

Housing

The compact housing is made of aluminum. It contains a top hat rail mount and a front cover with all interfaces for better overview in the control cabinet. The technician will note the convenience while working at the bus cabling.

Clamps and cabling

Using the 3-wire connection technology, all sensors and actuators can be connected directly to the module. The danger of incorrect wiring is greatly reduced by the color coding of the potentials, even for less experienced users. Various terminal strips are available, which are optionally equipped with LEDs. However, these should only be used for digital inputs and outputs.

LEDs and switches

All inputs and outputs can be monitored with the help of LEDs at the clamps. In addition to that, you can configure the baud rate and module address with HEX switches at the front cover – easy and comfortable.

Signal processing

Besides its inputs and outputs the Multi-IO offers a powerful microcontroller that handles data acquisition of sensors, control of actors and the processing of any CAN data. An important safety function is the Multi-IOs guarding capability which is fully integrated into the IO for network surveillance. Furthermore, there is a relay contact (changeover) as an additional safety measure. If there is an absence of guarding by the master registered, the module immediately goes into STOP-mode.

CAN interface

The integrated CAN interface is designed in accordance to DS 301 and 401 for a flexible use in different places and tasks in the CAN bus network. All Sontheim CAN interfaces comply to ISO 11898.

Power supply

The Multi-IO is supplied with 24 V. The integrated reverse polarity protection prevents possible destruction of the IO mode if the supply voltage is incorrectly applied. The control section is additionally protected against short overvoltage peaks by an EMC circuit on the supply voltage.

Highside and Lowside switch

All digital outputs can be fitted with a Highside or Lowside switch. Being Highside, the outputs toggle the supply voltage to load.

Pin assignment

Clamp block

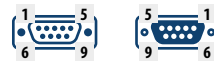
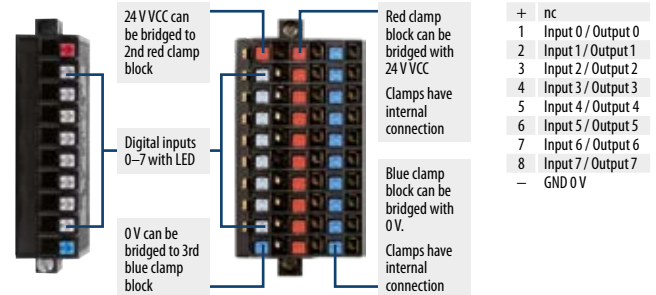

CAN D-Sub9

1	–
2	CAN low
3	CAN GND
4	–
5	–
6	–
7	CAN high
8	–
9	–



HEX-Switches module address

Minimum 01 HEX	1
Maximum 7F HEX	127



HEX-Switch baud rate

0	50
1	125
2	250
3	500
4	1000

Technical Data

Hardware	
CPU	Motorola MC9S12DP256B
CAN interface	1x CAN acc. to ISO 11898, galv. isolated
CAN protocol	DS 301 and 401
Terminal block	Connection wire Ø 0.25 mm ² up to 1.5 mm ²
Operating system display	1x LED green for supply voltage (5 V) 1x LED green for operating mode (Run) 1x LED red for error status (Err)
Dimension (l×w×h)	241 mm × 120 mm × 48 mm
Weight	approx. 800 g
Protection class	IP20
Storage temperature	-10 °C up to +70 °C
Operating temperature	0 °C up to +60 °C
Humidity	90 % non-condensing
Power supply	24 V DC ±20 %
Power consumption	approx. 500 mA

Digital inputs	
Number of inputs	16
Circuit type	positive switching inputs
Potential isolation	Optocoupler
Display (directly at the clamp)	LED (green) for set inputs
Switching level "1"	+15.0 V up to +28.8 V
Switching level "0"	0.0 V up to +8.0 V
Input current/input	8 mA
Signal delay	< 200 µs

Digital outputs	
Number of outputs	16
Circuit type	FET-Highside switch
Potential isolation	Optocoupler
Output voltage	Supply voltage – approx. 0.3 V
Display (directly at the clamp)	LED (green) for activated output
I _{out} Max	1 A
Sampling frequency	1 kHz
Short circuit resistance	Yes
Freewheel diodes	Yes, each activated coil must be provided with a freewheel diode
Signal delay	< 100 µs

Analog inputs	
Number of inputs	8, together galv. isolated
Resolution	12 bit
Potential isolation	Optocoupler
Input voltage	-10 V up to +10 V DC
Sampling frequency	Up to max. 12 analog inputs in operation: 1 kHz more than 12 analog inputs in operation: 500 Hz

Analog outputs	
Number of outputs	8, together galv. isolated
Resolution	12 bit
Potential isolation	Optocoupler
Output voltage	-10 V up to +10 V DC
I _{out} Max	20 mA
Filter circuitry	integrated

Encoder-inputs	
Number of inputs	4
Level	RS485 (A and B)
Max. input frequency	300 kHz
Input voltage	5 V (to supply the encoder)
I _{out} Max	80 mA (to supply the encoder)
Galvanic isolation	Optocoupler

Order information

V966105000	Multi-IO_RM35 24 V IO High-Side
V966105300	Multi-IO_RM35 12 V IO High-Side
V966105400	Multi-IO_RM35 12 V IO Low-Side
V980109000	Weidmüller BL IO-30-pole with LED (not included in delivery)
V980109100	Weidmüller BL IO-30-pole without LED (not included in delivery)
V980109200	Weidmüller BL IO-10-pole with LED (not included in delivery)
V980109300	Weidmüller BL IO-10-pole without LED (not included in delivery)



Quality

We live electronics – and also quality. That's why we set ourselves the goal of implementing it in every area. We create customer satisfaction through a holistic quality culture for the company, processes, products and services. We want to create real added value for our customers and maintain and build long-term relationships. The basic prerequisite for this is consistently high quality – based on standards and certifications.













Super-IO

Super-IO is a digital 24 V input and output module with 160 digital inputs and 192 digital outputs. It is optimally suited for the use in CAN networks. The device possesses the shortest conversion times and a high process reliability. That makes it the best choice for continuous operation in complex machine networks.

Key Features

- 
Safety features for high running safety
- 
Galv. isolated CAN interface acc. to ISO 11898
- 
Easy access to all interfaces
- 
Own intelligence for complex CAN networks
- 
All clamps pluggable and lockable
- 
Signal delay of less than 400 µs
- 
Galv. isolated inputs
- 
Compact aluminium housing with IP20 and integrated top hat rail mounting

Overview of interfaces

- 160 digital inputs, divided into 5 blocks of 32 channels
- 192 digital outputs, divided into 6 blocks of 32 channels

Housing and clamps

The compact housing is made of aluminium. It contains a top hat rail mount and a front cover with all interfaces for better overview in the control cabinet. The technician will note the convenience while working at the bus cabling. The module uses very robust clamps and cabling for the connection to sensors and actors. In order to maximize the resistivity against mechanical force, all clamps can be locked.

LEDs and switches

You can configure the baud rate and module address with HEX switches at the front cover – easy and comfortable. Moreover, there is a 7-segment display as well as some LEDs for showing the device status.

Technical Data

Hardware	
CPU	16-bit microcontroller
CAN	1x CAN acc. to ISO 11898, galvanically isolated; Connection with two RJ45 socket (bridged)
CAN protocol	DS 301 and 401
Setting	of module address via 2 HEX switches of baud rate via HEX switch
Connection system	D-Sub50 clamp, lockable
Operating system display	1x LED green (run) for operating mode 1x LED red (error) for error status 1x LED green (power) for supply voltage 1x 7-Segment display for module activities like Init, Pre-Operational, Operational and error
Dimensions (l×w×h)	240 mm × 125 mm × 90 mm
Protection class	IP20, EMC-requirements according to CE
Storage temperature	-30°C up to +70°C
Operating temperature	0°C up to +60°C
Humidity	90 % non-condensing
Power supply	24 V DC ±20 %

Digital inputs	
Number of inputs	160
Switching level "1"	+15.0 V up to +28.8 V
Switching level "0"	0.0 V up to +8.0 V
Potential isolation	Optocoupler
Input current/input	11 mA
Sampling frequency (Fg)	5 kHz
Signal delay	< 100 µs

Digital outputs	
Number of outputs	192
Power	24 V DC ±20 %
Circuit type	FET-Highside switch
Potential isolation	Optocoupler
Output current/output	500 mA
Total current of the module	8 A
Sampling frequency	1 kHz

Signal processing and CAN interface

Besides its inputs and outputs the Super-IO offers a powerful microcontroller that handles data acquisition of sensors, control of actors and the processing of any CAN data. An important safety function is the guarding capability which is fully integrated into the IO for network surveillance. If there is an absence of guarding by the master registered, the module immediately goes into STOP-mode. The integrated CAN interface is designed in accordance to DS 301 and 401 for a flexible use in different places and tasks in the CAN bus network. All Sontheim CAN interfaces comply with ISO 11898.

Customized adaptations

Quite often, the specific requirements of an automation process make it necessary to have an IO module meeting individual needs. This is particularly the case for the number and type of in- and outputs, the fieldbus, the current supply of the module and IO channels and many more details. It is our pleasure to adapt the module to your processes.

Order information

V966185000	Super-IO
------------	----------



IAO08

The analog output module IAO08 is a powerful device for forwarding analog signals. The device possesses the shortest conversion times and a high process reliability. That makes it the best choice for continuous operation in complex machine networks.

Key Features



Safety features for high running safety



Galv. isolated CAN interface acc. to ISO 11898



Easy access to all interfaces



Own intelligence for complex CAN networks



Signal delay of less than 400 µs



Galv. isolated inputs



Compact aluminium housing with IP20 and integrated top hat rail mounting

Housing

The compact housing is made of aluminium. It contains a top hat rail mount and a front cover with all interfaces for better overview in the control cabinet. The technician will note the convenience while working at the bus cabling.

Switches

You can configure the baud rate and module address with HEX switches at the front cover – easy and comfortable.

Signal processing

Besides its outputs the IAO08 offers a powerful micro-controller that handles the control of actors and the processing of any CAN data. An important safety function is its guarding capability which is fully integrated into the IO for network surveillance. Furthermore, there is a relay contact (changeover) as an additional safety measure. If there is an absence of guarding by the master registered, the module immediately goes into STOP-mode.

CAN interface

The integrated CAN interface is designed according to DS 301 and 401 for a flexible use in different places and tasks in the CAN bus network. All Sontheim CAN interfaces comply to ISO 11898.

Technical Data

Hardware	
CPU	16-bit microcontroller
CAN	1x CAN acc. to ISO 11898, galv. isolated
Operating system display	1x LED green for supply voltage (5 V) 1x LED green for operating mode (run) 1x LED red for error status (err)
Dimensions (l×w×h)	241 mm × 120 mm × 48 mm
Weight	ca. 800 g
Protection class	IP20
Storage temperature	-10 °C up to +70 °C
Operating temperature	0 °C up to +60 °C
Humidity	90 % non-condensing
Power supply	24 V DC ±10 %
Total current	approx. 500 mA

Analog outputs	
Number of outputs	8
Resolution	12 bit
Potential isolation	Optocoupler
Output voltage	-10 V up to +10 V DC
I _{out max}	20 mA
Filter circuitry	integrated

Pin assignment



Analog outputs

1	-
2	-
3	-
4	ANAOUT
5	ANAOUT
6	ANAGND
7	ANAGND
8	-
9	GND



HEX-Switch baud rate

0	50
1	125
2	250
3	500
4	1000



CAN interface

1	CAN H (high)
2	CAN L (low)
3	GND

Order information

V966301000	IAO08 – 8x AnaOut
------------	-------------------



IDI 32

IDI32 is a digital 32-channel 24 V input module for the use in CAN networks. The device possesses the shortest conversion times and a high process reliability. That makes it the best choice for continuous operation in complex machine networks.

Key Features



Safety features for high running safety



Galv. isolated CAN interface acc. to ISO 11898



Easy access to all interfaces



Own intelligence for complex CAN networks



Signal delay of less than 400 µs



Galv. isolated inputs



Compact aluminium housing with IP20 and integrated top hat rail mounting

Clamps and cabling

A very important feature of the IDI32 in its different versions is the really sturdy way in which the connection of actors and sensors is handled. 24 V, data and GND have separate connectors (3-wire-connection). We use phoenix clamps for simple and rugged connections. Every IO-block of the device is galvanically isolated and has its own power supply. Thus, all IDxx modules can be used in safety-relevant environments. An example for a typical application is the CAN handling of emergency-stop circuits like guard doors.

CAN interface

Two RJ45 connectors at the front cover facilitate the connection with other CAN participants over ethernet patch cable. The IDI32 can also be used in a decentralised CAN network.

LEDs and switches

All inputs and outputs can be monitored with the help of LEDs at the clamps. In addition to that, you can configure the baud rate and module address with HEX switches at the front cover – easy and comfortable.

Technical Data

Hardware	IDI32	IDO32	IDIO32
CPU	16-bit microcontroller		
CAN	Galvanically isolated acc. to ISO 11898, connection via two RJ45 connectors (bridged)		
CAN protocol	DS 301 and 401		
Number of modules/bus	127		
Setting	of module address via 2 HEX-switches of baud rate via HEX-switch		
Connection system	Spring connection clamping range 0.25 – 1.5 mm ² , solid wire "e", fine wire "f" 0.25 – 1.5 mm ² , "f" with wire end ferrule, without plastic collar 0.25 – 1.5 mm ²		
Connection technology	Two-wire and three-wire connection, stripping length 10 mm		
Operating status display	1x LED green for power supply (5V) 1x LED green for operation mode (Run) 1x LED red for error status (Err) 32x LED green for set inputs	1x LED green for power supply (5V) 1x LED green for operation mode (Run) 1x LED red for error status (Err) 32x LED green for set outputs (at the clamp)	1x LED green for power supply (5V) 1x LED green for operation mode (Run) 1x LED red for error status (Err) 16x LED green for set inputs 16x LED green for set outputs (at the clamp)
Dimensions (l×w×h)	241 mm × 120 mm × 48 mm		
Weight	850 g		
Protection class	IP 20, EMC-requirements acc. to CE		
Operating temperature	0°C up to +60°C		
Storage temperature	–30°C up to +70°C		
Humidity	90 % non-condensing		
Power supply	24 V DC ±20%		
All inputs/outputs active, incl. LEDs	400 mA		470 mA

Digital inputs	IDI32	IDO32	IDIO32
Number of inputs	32	–	16
Switching level "1"	+15.0 V up to +28.8 V DC	–	+15.0 V up to +28.8 V DC
Switching level "0"	0.0 V up to +8.0 V DC	–	0.0 V up to +8.0 V DC
Potential isolation	Optocoupler	–	Optocoupler
Input current/input	11 mA	–	11 mA
Sampling frequency (Fg)	2.5 kHz	–	2.5 kHz
Signal delay	< 400 μs	–	< 400 μs

Digital outputs	IDI32	IDO32	IDIO32
Number of outputs	–	32	16
Power	–	24 V DC ±20%	
Circuit type	–	FET-Highside-Switch	
Potential isolation	–	Optocoupler	
Output current/output	–	1 A (short circuit proof)	
Total current of the Module	–	8 A	
Total current of the Module with blockwise supply	–	16 A	
Switching frequency	–	1 kHz	
Freewheel diodes	–	Yes, controlled inductors require external freewheel diodes	
Signal delay	–	< 100 μs	

Pin assignment



9-pole phoenix clamp

Top connector 24V	
1	24V
2	Input 1 / Output 1
3	Input 2 / Output 2
4	Input 3 / Output 3
5	Input 4 / Output 4
6	Input 5 / Output 5
7	Input 6 / Output 6
8	Input 7 / Output 7
Bottom connector 0V	



CAN RJ 45

1	–
2	–
3	–
4	CAN low
5	CAN high
6	–
7	CAN GND
8	–



HEX-Switches module address

Minimum 01 HEX	1
Maximum 7F HEX	127



HEX-Switch baudrate

0	10
1	20
2	50
3	125
4	250
5	500
6	800
7	1000

Order information

V966116000	IDI32
V966126000	IDO32
V966128000	IDIO32

eControl-IO



The key to lean fieldbus networks and efficient process automation is flexibility. The user must be able to cope with rapidly changing process requirements with existing resources. The eControl IO-module was developed specifically for the use in machine networks and with its numerous expansion modules it provides many applications in industrial environments and is the ideal supplement for all PLCs of the eControl family.

Key Features



CANopen acc. to CiA Draft Standard DS 301 and 401



Fast in- and outputs, short signal delay



CAN baud rate up to 1 Mbit/s



Numerous expansion options (up to 6 expansion modules)



Compact aluminium housing with IP20 and integrated top hat rail mounting

Master module and CAN interface

The master module is the basis of the eControl IO module and is required in each constellation. The entire IO system is controlled by an integrated microcontroller, while already 16 digital outputs, 16 digital inputs, two analog outputs and two analog inputs are integrated. The module has an LED status indicator to show the status of the module and the switching states of the digital IOs. As an interfaces for data exchange, it has two RJ45 ports for the CAN bus which allows an easy and fast connection. Via DIP switch the module ID and baud rate of the CAN bus can be set conveniently.

High flexibility through individual expansion options

An expansion interface enables the connection of up to six IO modules. The modules and the order can be freely selected. The addressing of the expansion modules is performed automatically and the master module detects the plugged in module and the addressing. As extension options we provide currently a motor module, analog module, digital module or temperature module.

Rugged interfaces

The Phoenix clamps ensure a simple and extremely robust connection that makes the module in combination with the robust aluminium housing very durable and reliable.

Technical Data

Master module	
CAN	2× CAN acc. to ISO 11898 via RJ45 (2× socket)
Internal bus	Serial interface
Clamping technology	Pluggable phoenix clamp RM 3.5
Digital inputs	16× DI, typically 0–24 V, max. 28.8 V; input current at rated voltage < 1–5 mA
Digital outputs	16× DO, typically 0–24 V, max. 28.8 V; 0.5 A maximum power per output; Protection against thermal overload
Analog inputs	2 contacts as reference-GND; 2 contacts for the analog inputs; Input voltage range: 0 V up to +10 V; Input current at +10 V: < 1 mA; Resolution: 10 bit
Analog outputs	2 contacts as reference-GND; 2 contacts for the analog outputs; Output voltage range: 0 V up to +10 V; Maximum output current 10 mA; Resolution: 10 bit
Dimensions (l×h)	180 mm × 120 mm
Temperature sensor	integrated
Storage temperature	–20 °C up to +70 °C
Operating temperature	0 °C up to +60 °C (extended temperature range is optionally available)
Supply	24 V ±10 % – via 3-pole phoenix clamp
Supply IO	24 V ±10 % – via 3-pole phoenix clamp

Expansion modules	8DI/8DO	2H-bridge	PT100/PT1000	2AI/2AO	Relay module
DI 24 V	8	–	–	–	–
DO 24 V	8	–	–	–	–
AI 0–10 V	–	–	–	2	–
AO 0–10 V	–	–	–	2	–
PT 100/1000	–	–	2	–	–
Engine bridge 10 A	–	2	–	–	–
Potential-free contacts 6 A	–	–	–	–	4
CAN – adress settings	automatically				
CAN baud rate	over master module				
Power supply	24 V				

eControl PLC as a master with CODESYS V3

The PLCs of the eControl family are equipped with numerous communication interfaces, such as CAN, Ethernet, USB and serial interfaces. The PLCs have powerful CPUs which are optimized for the CODESYS target and web visualization. The robust and compact design in combination with CODESYS V3 as a development environment open up a variety of applications in industrial environments.

Pin assignment



CAN RJ 45

2	CAN low
3	CAN high
4	CAN GND
7	CAN GND



DIP switch baud rate

0	50
1	125
3	250
4	500
5	1000



DIP switch module address

Minimum 01 HEX	1
Maximum 7F HEX	127

Order information

V965201110	Master module 16 DI/16 DO / 2 AI/2 AO 10 bit
V965201210	Module 2. 8 DI/8 DO
V965201310	Module 3. 2H bridge 10A
V965201410	Module 4.1. 2 PT 100/1000
V965201420	Module 4.2. 4 PT 100/1000
V965201510	Module 5. 2 AI/2 AO 10 bit
V965201610	Module 6. Relay module

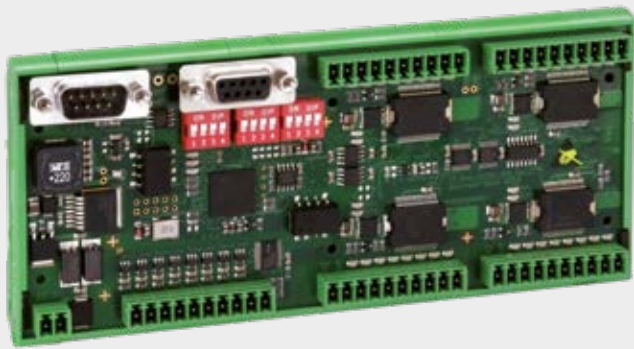

Embedded-IO

The entire light series was designed for maximum cost savings at the same high performance. So far, it covers modules for signal processing of relays, temperature sensors and digital inputs and outputs. All the modules have an open and slim chassis design, which is clearly designed for the installation in the control cabinet.

Key Features



CANopen according to CiA Draft Standard DS 301 and DS 401



Short signal delay



Short circuit proof outputs



CAN baud rate up to 1 Mbit/s



Small dimensions



Simple top hat rail mounting

Interfaces

The modules are compact and they have comfortable design, which provides all the interfaces, LEDs and required switches on the front panel. Another feature is the integrated top hat rail mounting, which permits an easy mounting and dismounting.

LEDs and switches

The visualization of the status and current IO states successes via integrated LEDs for each IO. Configuring the module address and baud rate can be made easily and safely via DIP switches on the module. Thereby, a baud rate of up to 1 Mbit/s is adjustable according to CiA.

In- and outputs

The modules are available in partly configurable models with digital or analog inputs and outputs. They are galvanically isolated and short-circuit-proofed and guarantee a high reliability and resiliency. The wide input voltage range of 12 V DC to 30 V DC, open up wide areas of applications.

Signal processing

In addition to the inputs and outputs, the module has a powerful microcontroller, worked on the acquisition of the sensors, the control of actuators and the CAN protocol. Further, security mechanisms such as e.g. guarding are fully integrated into the remote IO.

CAN interface

The integrated CAN interface according to CANopen (DS 301 and 401) allows flexible use at different locations and positions in the production process. It is executed according to ISO 11898 and can be bridged. In this way, you can use several modules in series by looping through the CAN signals.

Combine the light modules with IPC-4 as a master in the CAN network

In its latest generation the IPC-4 combines the know-how of a system provider with the latest technology and is perfectly tailored for applications in the automation and automotive industry.

The new IPC with its scalable performance, clearly deposits itself from the competition. Computing power as well as the type and number of interfaces are offering immense possibilities for individual adjustment, for a maximum of flexibility. The housing is of course suitable for top hat rail mounting and allows an access to all ports on the front panel. This ensures a comfortable handling and avoids messy cabling.

Example of an automation application

IPC-4 is a master unit in the automation system and handles the control as well as the sensors and actors in a fieldbus network.

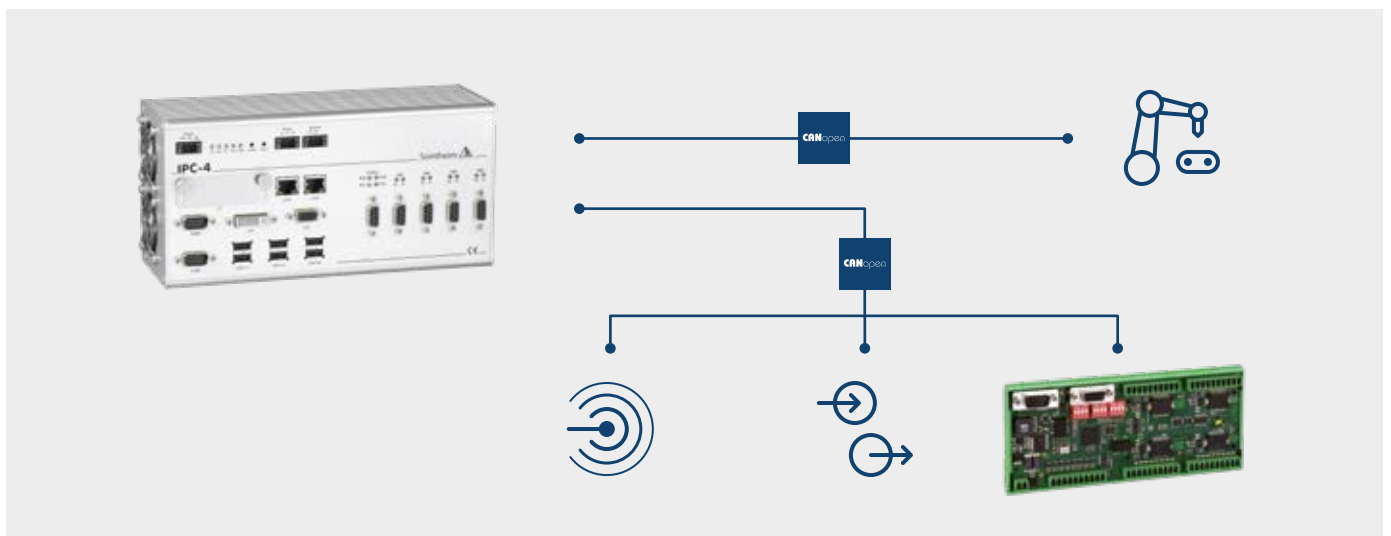

Technical Data

Module overview	DIO32-L	DIO32 8AI-L	AIO16-L
CAN	1x CAN interface acc. to ISO 11898, assignment acc. to DIN 41652, connection with D-Sub9 plug and socket (bridged)		
CAN protocol	DS 301 and 401		
Number of modules/bus	127		
Setting	of module address via 2 HEX switches, of baud rate via HEX switch		
Connection system	Clamping range 0.25 – 1.5 mm ² , solid wire		
Connection type	Spring connection		
Connection technology	Two-, three-wire connection, stripping length 10 mm	one-wire connection, stripping length 10 mm	
Operating system display	1x LED green for operating mode (run) 1x LED red for error status (err) 32x LED green for set in- and outputs	1x LED green for operating mode (run) 1x LED red for error status (err) 1x LED green for supply voltage 32x LED green for set in- and outputs	1x LED green for operating mode (run) 1x LED red for error status (err) 1x LED green for supply voltage
Dimensions (l×w×h)	147 mm × 77 mm × 37 mm	166 mm × 72 mm × 37 mm	147 mm × 77 mm × 37 mm
Weight	155 g without clamps	102 g without clamps	
Type of installation	Top hat rail		
Storage temperature	–20 °C up to +70 °C		
Operating temperature	0 °C up to +60 °C (extended temperature range is optionally available)		
Humidity	90 % non-condensing		
Conformity EMC-requirements	EN 61000-6-4 and EN 61000-6-2 (Industrial sector)		
Power supply	12 V DC up to 30 V DC	12 V DC ±20 % and 24 V DC ±20 %	
Current	30 mA 350 mA (all in- and outputs active, including LEDs)	90 mA 220 mA (All in- and outputs active, including LEDs)	
Digital inputs	DIO32-L	DIO32 8AI-L	AIO16-L
Number of inputs	16	0–32, configurable in 8-blocks	–
Switching level "1"	+8.0 V up to +30.0 V	+11.0 V up to +28.8 V	–
Switching level "0"	0.0 V up to +4.0 V	0.0 V up to +5.0 V	–
Potential isolation	Capacitive coupler		–
Input current/input	3.0 / 6.5 mA	4 mA	–
Sampling frequency	2.5 kHz	1 kHz	–
Signal delay	< 100 µs		–
Digital outputs	DIO32-L	DIO32 8AI-L	AIO16-L
Number of outputs	16	0–32, configurable in 8-blocks	–
Circuit type	FET-Highside-Switch		–
Potential isolation	Capacitive coupler		–
min. output voltage	VB – 0.85 V	VB – 0.16 V DC	–
max. output current per channel	600 mA	625 mA	–
max. total output current	8 A	16 A	–
Protective shutdown	Short circuit and overload protection		–
Switching frequency	1 kHz		–
Free-wheeling diodes	Yes, controlled inductors require external freewheel diodes		–
Signal delay	< 100 µs		–
Analog inputs	DIO32-L	DIO32 8AI-L	AIO16-L
Number of inputs	–	8	
Resolution	–	12 bit	
Potential isolation	–	Capacitive coupler	
Input voltage	–	If required with assembly option: current input: 4 to 20 mA (not standard)	
Samplerate	–	1 kHz	
Analog outputs	DIO32-L	DIO32 8AI-L	AIO16-L
Number of outputs	–	8	
Resolution	–	12 bit	
Potential isolation	–	Capacitive coupler	
Output voltage	–	0–10 V DC	
I _{out} Max	–	250 mA per output	

DIO32-L

DIO32 8AI-L

AIO16-L



Pin assignment DIO32-L



DIP switch module address

Minimum 01 HEX	1
Maximum 7F HEX	127



DIP switch baud rate (in Kbit/s)

0	50
1	125
3	250
4	500
5	1000



CAN D-Sub9

1	–
2	CAN low
3	CAN GND
4	–
5	–
6	–
7	CAN high
8	–
9	–



Clamp block

1	E1.0	Digital input / output 1.0
2	E1.1	Digital input / output 1.1
3	E1.2	Digital input / output 1.2
4	E1.3	Digital input / output 1.3
5	E1.4	Digital input / output 1.4
6	E1.5	Digital input / output 1.5
7	E1.6	Digital input / output 1.6
8	E1.7	Digital input / output 1.7

Pin assignment DIO32-8AI-L, AIO16-L



DIP switch module address

Minimum 01 HEX	1
Maximum 7F HEX	127



DIP switch baud rate (in Kbit/s)

0	50
1	125
3	250
4	500
5	1000



CAN D-Sub9

1	–
2	CAN low
3	CAN GND
4	–
5	–
6	–
7	CAN high
8	–
9	–

Order information

V965100000	DIO32-L
V965100100	DIO32 8AI-L
V930250210	DIO32 8AI-L (4× Spannungs- & 4× Stromeingänge)
V965100200	AIO16-L

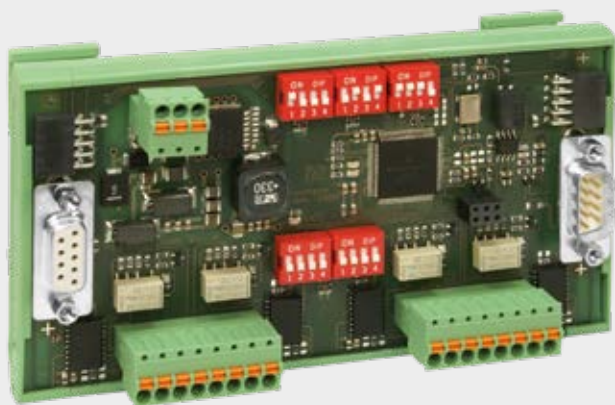

TM-PT100/ 1000-L

Temperatures can easily be measured with the TM-PT100/1000-L with up to eight sensors. It contains possibilities for 4-wire and 2-wire technologie and thus provides a great amount of industrial-suitedness.

Key Features



CANopen according to CiA Draft Standard DS 301 and 401



CAN baud rate up to 1 Mbit/s



Small dimensions



Free choice of connection technology (4-wire/2-wire) and resistance sensors (PT100/PT1000)



Up to 8 measuring sensors per Module



Simple top hat rail mounting

Housing

The compact housing is made for being in a control cabinet. It contains a top hat rail mount and a front cover with all interfaces for better overview in the control cabinet. The technician will note the convenience while working at the bus cabling.

LEDs and switches

All inputs and outputs can be monitored with the help of LEDs. In addition to that, you can configure the baud rate of up to 1 Mbit/s and module address with DIP switches at the front cover. An additional DIP switch is meant for switching between 4-wire and 2-wire.

Measuring

The data is collected with four (4-wire) or eight (2-wire) sensors. You can choose between PT100 and PT1000 sensors and set the measurement speed to slow-mode with 100 ms or quick mode with 10 ms per channel and cycle.

Technical Data

CPU	16-bit microcontroller
CAN	1x CAN interface acc. to ISO 11898, galv. isolated, connection with D-Sub9 plug and socket (bridged), assignment acc. to DIN 41652
CAN protocol	DS 301 and 401
Number of modules/bus	127
Setting	of module address via 2 DIP switches of baud rate via DIP switch Resistance sensor selection via DIP switch Selection of the connection technology via DIP switch
Connection system	Rigid lines 0.20 – 1.50 mm ² Flexible lines 0.20 – 1.50 mm ²
Connection type	Spring connection and gold contacts
Connection technology	Optional 4-wire and/or 2-wire
Operating system display	1x LED green for operating mode (run) 1x LED red for error status (err) 1x LED green for VCC
Dimensions (l×w×h)	137 mm × 77 mm × 37 mm
Weight	140 g without clamps
Type of installation	Top hat rail
Storage temperature	–30 °C up to +70 °C
Operating temperature	0 °C up to +60 °C (extended temperature range is optionally available)
Humidity	90 % non-condensing
Conformity to EMC requirements	EN 61000-6-4 and EN 61000-6-2 (Industrial sector)
Supply voltage (VB)	12 V DC up to 30 V DC
Power consumption	30 mA
All in- and outputs active, including LEDs	350 mA

Signal processing

A STAR 12 microcontroller handles the sensors and the CAN protocol. TM-PT is also suited for control tasks via PWM/IO-interface.

CAN Interfaces

The integrated CAN interface is designed in accordance to DS 301 and 401 for a flexible use in different places and tasks in the CAN bus network. All Sontheim CAN interfaces comply to ISO 11898.

Pin assignment



DIP switch module address

Minimum 01 HEX	1
Maximum 7F HEX	127

CAN D-Sub9



1	–
2	CAN low
3	CAN GND
4	–
5	–
6	–
7	CAN high
8	–
9	–



DIP switch baud rate (in Kbit/s)

0	50
1	125
3	250
4	500
5	1000



Clamp block

1	E1.0	Sensor 1
2	E1.1	Sensor 2
3	E1.2	Sensor 3
4	E1.3	Sensor 4
5	E1.4	Sensor 5
6	E1.5	Sensor 6
7	E1.6	Sensor 7
8	E1.7	Sensor 8

Order information

V965101000	TM-PT100/1000-L
------------	-----------------



EC-DIO32

Digital 24 V module with 32 freely configurable in- and outputs and an EtherCAT and CAN interface.

Key Features



Signal delay with less than 400 μ s



Safety features for high running safety



Easy access to all interfaces



Own intelligence for complex EtherCAT networks



Galv. isolated in- and outputs



Free configuration of in- and outputs



Analog and digital diagnostic functions



Compact aluminium housing with IP20 and integrated top hat rail mounting

Flexibility

The key to slim fieldbus networks as well as to efficient process automation is flexibility. The user has to be able to meet changing process requirements with existing products. The EC-DIO32 has been designed for these particular cases, where either the fieldbus system, the number or the kind of actors and sensors changes.

Freely configurable inputs and outputs

EC-DIO32 is a digital 24 V remote IO module, housing a 16-bit Motorola Freescale microprocessor and 32 freely configurable inputs and outputs. It is separated into four blocks of 8 interfaces each that can be configured and addressed via HEX-switches. Every block is galvanically isolated and has an own power supply. This enables the module to handle different voltages and allows the use in safety-relevant applications, e.g. guard doors.

Displays, switches and LEDs for a maximum of usability

LEDs and two 7-segment displays for each block show the status of the module channels. The network can therefore be created and monitored very easily.

Technical Data

Hardware	
CPU	16-bit microcontroller
Connection technology	Two-wire, three-wire connection
Operating system display	1x LED green for supply voltage (5 V) 1x LED green for operating mode (run) 1x LED red for error status (err) 32x LED green for set input/output
Dimensions (l×w×h)	241 mm × 120 mm × 48 mm
Weight	850 g
Protection class	IP20, EMC-requirements acc. to CE
Storage temperature	-30°C up to +70°C
Operating temperature	0°C up to +60°C
Humidity	90 % non-condensing
Power supply	24 V DC ±20 %
Total current (all in- and outputs active, including LEDs)	500 mA

Rugged interfaces

3-point connection technology facilitates the direct connection of all sensors and actors with the module. The EC-DIO32 contains Phoenix clamps for easy and rugged contact, making it robust and process proof in multiple applications.

EtherCAT and CAN interfaces

Many automation processes need a decentralized deployment of communication modules. That is why the EC-DIO32 has a 3-pole CAN interface and two RJ45 plugs for connecting different modules via Ethernet patch cable. In addition to that there is an automatic detection of CAN and EtherCAT network technology.

Diagnostic features via revertive monitoring

The device offers various possibilities for revertively monitoring power levels and switching habits. These features facilitate the detection of defect outputs. By monitoring the levels of input signals the module can also verify input faults. All the data is made available while running the EC-DIO32. It is also possible to implement a current measurement at the inputs and outputs for controlling absorption and delivery.

Digital inputs	
Number of inputs	Freely configurable in 8-blocks (max. 32)
Switching level "1"	+15.0 V up to +28.8 V
Switching level "0"	0.0 V up to +8.0 V
Potential isolation	Optocoupler
Input current/input	11 mA
Sampling frequency (Fg)	2.5 kHz
Signal delay	< 400 µs

Digital outputs	
Number of outputs	Freely configurable in 8-blocks (max. 32)
Power	24 V DC ±20 %
Circuit type	FET-Highside switch
Potential isolation	Optocoupler
Output current/output	1 A (short circuit proof)
Freewheel diodes	Yes, controlled inductors require external freewheel diodes
Signal delay	< 100 µs
Relay contact (when module active)	1x UM / 1 A
Switching level "1"	+15.0 V to +28.8 V DC

Pin assignment



RJ 45 Ethernet

1	LAN/EtherCAT_TX+
2	LAN/EtherCAT_TX-
3	LAN/EtherCAT_RX+
4	CAN L (low) (optional)
5	CAN H (high) (optional)
6	LAN/EtherCAT_RX-
7	CAN GND (ground) (optional)
8	-



RJ 45

4	CAN L (low)
5	CAN H (high)
7	CAN GND



HEX-Switches module address

Minimum 01 HEX	1
Maximum 7F HEX	127



HEX-Switch baud rate (in Kbit/s)

0	10
1	25
2	50
3	125
4	250
5	500
6	800
7	1000

Order information

V966210000

EC-DIO32



EC-DIO32 RM35

Digital 24 V module with 32 freely configurable in- and outputs and an EtherCAT and CAN interface.

Key Features



Signal delay with less than 100 µs



Safety features for high running safety



Easy access to all interfaces



Own intelligence for complex EtherCAT networks



Galv. isolated in- and outputs



Free configuration of in- and outputs



Analog and digital diagnostic functions



Compact aluminium housing with IP20 and integrated top hat rail mounting

Flexibility

The key to lean fieldbus networks and efficient process automation lies in flexibility. The user has to be able to meet changing process requirements with existing products. The EC-DIO32 RM35 has been designed for these particular cases, where either the fieldbus system, the number or the kind of actors and sensors changes.

Freely configurable inputs and outputs

EC-DIO32 RM35 is a digital 24 V remote IO module, housing a 200 MHz NXP LPC with 32-bit and 32 freely configurable inputs and outputs. It is separated into four blocks of eight interfaces each that can be configured and addressed via two HEX-switches. Every block is galvanically isolated and has an own power supply. This enables the module to handle different voltages and allows the use in safety-relevant applications, e. g. guard doors.

Switches and LEDs for a maximum of usability

LEDs and switches for each block show the status of the module channels. The network can therefore be created and monitored very easily.

Technical Data

Hardware	
CPU	32-bit microcontroller
Connection technology	Two-wire-, three-wire connection
Operating system display	1x LED green for operating mode (Run) 1x LED rot for error (Err) 1x LED green mode CAN 1x LED green mode EtherCAT 4x LED Block configuration 32x LED green for set in- and outputs
	Fieldbus EtherCAT (LEDs on the RJ45 plug) 1x LED green transmit 1x LED orange EtherCAT status
Dimensions (l×w×h)	121 mm × 120 mm × 35 mm
Weight	approx. 400 g
Portection class	IP20, EMC-requirements according to CE
Storage temperature	-20°C up to +80°C
Operating temperature	-10°C up to +60°C
Humidity	90 % non-condensing
Power supply	24 V DC ±20 %
Current (all in- and outputs active, including LEDs)	500 mA

Rugged interfaces

3-point connection technology facilitates the direct connection of all sensors and actors with the module. The EC-DIO32 RM35 contains Weidmüller clamps for easy and rugged contact, making it robust and process proof in multiple applications.

EtherCAT and CAN interfaces

You can configure the module for a CANopen or EtherCAT network via a HEX switch. As interfaces for data exchange, it has two RJ45 ports and for CAN a D-Sub9 interface, allowing an easy connection with other modules.

Diagnostic features via revertive monitoring

The device offers various possibilities for revertively monitoring power levels and switching habits. These features facilitate the detection of defect outputs. By monitoring the levels of input signals the module can also verify input faults. All the data is made available while running the EC-DIO32 RM35.

Digital inputs	
Number of inputs	Freely configurable in 8-blocks (max. 32)
Switching level "1"	+15.0 V up to +28.8 V DC (EN 61131-2, type 1)
Switching level "0"	0.0 V up to +5.0 V DC (EN 61131-2, type 1)
Input current/input	max. 5 mA
Input frequency (Fg)	5 kHz
Signal delay	< 100 µs

Digital outputs	
Number of outputs	Freely configurable in 8-blocks (max. 32)
Power supply	24 V DC ±20 %
Circuit type	Highside-Power switch
Output current/output	1 A (short circuit proof)
Freewheel diodes	Yes, controlled inductors require external freewheel diodes
Signal delay	< 100 µs
Switching level "1"	+15.0 V up to +28.8 V DC

Pin assignment



RJ 45 Ethernet

1	LAN/EtherCAT_TX+
2	LAN/EtherCAT_TX-
3	LAN/EtherCAT_RX+
4	-
5	-
6	LAN/EtherCAT_RX-
7	-
8	-



HEX-Switches module address

Minimum 01 HEX	1
Maximum 7F HEX	127



HEX-Switch baud rate (in Kbit/s)

0	10
1	25
2	50
3	125
4	250
5	500
6	800
7	1000



CAN D-Sub9

2	CAN L (low)
3	CAN GND
7	CAN H (high)

Order information

V966213250

EC-DIO32 RM35



CAN-RS232 Interface- Converter

If you have occupied all serial interfaces, you can rely on the CAN-RS232 interface converter. It is a 24 V extension module for any desktop or industrial PC that provides another four RS232 channels according to CANopen with D-Sub9 plugs.

Key Features

- RS
232
Up to 4x RS232 interface with D-Sub9
- CAN
CAN interface acc. to ISO 11898 with 3-pole phoenix clamp
- CANopen
Complies with the CANopen specification according to CiA
- ⚡
24 V DC supply with 3-pole phoenix clamp
- ⚙️
Baud rate and module address configurable via HEX-switch
- ✓
Status LED-display for module status, CAN and each RS232 channel with Rx- and Tx-display

Housing

The compact aluminium housing is made for being in a control cabinet. It contains a top hat rail mount and a front cover with all interfaces for better overview in the control cabinet. The technician will note the convenience while working at the bus cabling.

Signal processing

Besides its inputs and outputs the Interface Converter offers a powerful microcontroller that handles data acquisition of sensors, control of actors and the processing of any CAN data.

CAN interface

The integrated CAN interface is designed in accordance to DS 301 and DS401 for a flexible use in different places and tasks in the CAN bus network. All Sontheim CAN interfaces comply to ISO 11898.

Technical Data

CPU	16-bit microcontroller
CAN	1x CAN acc. to ISO 11898, galvanically isolated, assignment acc. to DIN 41652
COM interface	Connection via D-Sub9 plug
RS232 interface	Connection via D-Sub9 socket
Dimensions (l×w×h)	187 mm × 120 mm × 60 mm
Housing	Aluminium housing, Protection class IP20
Supply voltage	24 V DC via 3-pole phoenix clamp
Mounting rail	TS35
Operating temperature	0°C up to +70 °C
Rel. Humidity	10 % up to 90 % non-condensing

Pin assignment



RS232

1	—
2	RxD
3	TxD
4	—
5	GND
6	—
7	—
8	—
9	—



CAN

1	CAN H (high)
2	CAN L (low)
3	CAN GND



HEX-Switch baud rate (in Kbit/s)

0	10
1	25
2	50
3	125
4	250
5	500
6	1000

Order information

V930882000	CAN-RS232 Interface-Converter
------------	-------------------------------



RS422 Multiplexer

24 V module with a total of 10 inputs for incremental encoder.

Key Features



Total of 10 inputs for incremental encoder



24 V DC supply with 3-pole phoenix clamp



Compact housing for TS35 top hat rail mounting

Overview of all interfaces

All interfaces of the inputs and outputs are designed as RS422, the signals are accessible via D-Sub9 plugs and sockets.

Housing

The aluminium module is extremely compact and offers the possibility of top hat rail mounting. All interfaces are conveniently available on the front panel.

LEDs and switches

In addition to several LEDs for displaying the operating status, the multiplexer has two LEDs each to indicate the status of the respective input. A 9-pole and a 3-pole phoenix connector are used for signal distribution.

Technical Data

RS232 interface	Connection via D-Sub9 socket
Number of digital inputs	10
Number of digital outputs	1
Maximum baud rate	500 kHz
Dimensions (l×w×h)	241 mm × 120 mm × 48 mm
Housing	Aluminium housing, Protection class IP20
Supply voltage	24 V DC via 3-pole phoenix clamp
Mounting rail	TS35
Operating temperature range	0°C up to +70°C
Rel. Humidity	10 % up to 90 % non-condensing

Switch data

Power supply	5 V
Level Input	±5 V
VIH	2 V
VIL	0.8 V
IOH	−440 µA
IOL	8 mA



IGI 16

IGI16 is designed for capturing positioning data according to CiA specification for CAN networks. The device possesses the shortest conversion times and a high process reliability. That makes it the best choice for continuous operation in complex machine networks.

Key Features



16 incremental encoder inputs with up to 32 bit resolution



CAN interface with 4-pole phoenix clamp



24 V DC supply with 3-pole phoenix clamp



Baud rate and module address configurable via HEX switch



Complies with the CANopen specification according to CiA

Housing

The compact aluminium housing contains a top hat rail mount and a front cover with all interfaces for better overview in the control cabinet. The technician will note the convenience while working at the bus cabling.

Incremental encoder

Overall, the IGI has 16 incremental encoder interfaces. Five of them are directly connected to counters. The sixth can be switched to D3 to D13. Inc A and B possess a resolution of 32 bit. All others work with a standard 16 bit resolution. Each encoder uses an impulse quadruplication for 20,000 impulses at 5,000 steps per turn.

LEDs and switches

All inputs can be monitored with the help of LEDs at the clamps. In addition to that, you can configure the baud rate with a HEX switch at the front cover – easy and comfortable.

Technical Data

CPU	16-bit microcontroller
CAN	interface according to ISO 11898 galv. isolated Connection with 4-pole phoenix clamp or optionally with RJ45 plug
Connecton system	D-Sub9 plug
Setting	of baud rate via HEX switch
Dimensions (l×w×h)	241 mm × 120 mm × 48 mm
Weight	800 g
Protection class	IP20, EMC-requirements according to CE
Storage temperature	-30 °C up to +70 °C
Operating temperature	0 °C up to +60 °C
Humidity	90 % non-condensing
Power supply	24 V DC ±20 %

Inputs

Number of inputs	16x for incremental encoder
Meter size	Inc A: 32 bit Inc B: 32 bit Inc C: 16 bit Inc D1: 16 bit Inc D2: 16 bit Inc D3 up to D13: 16 bit multiplexed
Fehlermodus	with watchdog error every 60 ms transmission of an error frame
Betriebszustandsanzeige	LEDs (red) for short circuit on Inc side LEDs (green) for multiplex-input RUN-LED (green) for identifier-reception ERROR-LED (red) for watchdogerror 24 V LED (green) for supply voltage

Signal processing

Besides its inputs the IGI16 offers a powerful microcontroller that handles the data acquisition of sensors and the processing of any CAN data.

CAN interface

The integrated CAN interface is designed in accordance to DS 301 and 401 for a flexible use in different places and tasks in the CAN bus network. All Sontheim CAN interfaces comply to ISO 11898.

Order information

V96630200

IGI – Incremental Encoder Interface 16 channel

Pin assignment



CAN

1	CAN H (high)
2	CAN L (low)
3	CAN GND
4	Erde



Incremental Encoder

1	GND
2	/B
3	GND
4	/A
5	24 V
6	24 V
7	GND
8	B
9	/A



HEX-Switch baud rate (in Kbit/s)

0	10
1	20
2	50
3	125
4	250
5	500
6	1000

Relay module



The relay module allows the control of up to eight heating cartridges with 400 V. It is designed in the open construction typical for the Light family and impresses with its very good price-performance ratio. With its extremely short conversion times for signal processing and high process reliability, this module is also ideally suited for continuous operation in complex machine networks.

Key Features



Controlling up to 8 heating cartridges



Integrated safety functions



Small dimensions



Simple top hat rail mounting

Housing

The compact housing is made for being in a control cabinet. It contains a top hat rail mount and a front cover with all interfaces for better overview in the control cabinet. The technician will note the convenience while working at the bus cabling.

Power supply

Phase L1 is only looped in. L2 and L3 are used for controlling the consumers. There is a current measurement integrated that enables a monitoring of each relay. It is build in two blocks with four relay each.

Relay

A key feature of the relay module is its high process reliability. Its RP1 is a semiconductor relay for embedded board assembly with three regulated control currents for handling its consumers. Major advantages are both a high surge current and interference resistivity while switching AC loads.

Technical Data

CPU	ARM 7-based
CAN	1× CAN interface according to ISO 11898, Connection with RJ45 socket
Operating system display	1× LED green for operating mode (run) 1× LED red for error status (err) 1× LED green for power supply
Setting	of module address via 2 HEX switches of baud rate via solder jumper
Dimensions (l×w×h)	285 mm × 77 mm × 37 mm
Weight	185 g with clamps 155 g without clamps
Type of installation	Hat rail
Storage temperature	−30°C up to +70°C
Operating temperature	0°C up to +60°C (extended temperature range is optionally available)
Humidity	90 % non-condensing
Conformity for EMC directives	EN 61000-6-4 and EN 61000-6-2 (Industrial sector)
Power supply	12 V DC up to 30 V DC

Relay-Data

Load voltage range	2 – 530 V AC
Peak reverse voltage	1000 V
Input – load circuit	4 kV AC
Nominal frequency range	45 – 65 Hz
Power factor	> 0.5
Switch-on zero voltage	< 10 V
Approvals	UL, cUL, VDE
CE-Identification	Yes

LEDs and switches

Several status LEDs allow to visualize different operating modes and warning messages from its safety functions like heartbeat telegrams. Configuration of the module address and baud rate can be done via HEX switches and solder jumpers. It is turned to 250 Kbit/s as a standard.

Signal processing

There is a powerful ARM7 microcontroller on the module for controlling the relay and the CAN protocol. Additionally, heartbeat is integrated into the device.

Order information

V966305100	RM-Relay module
------------	-----------------

Pin assignment



RJ 45

1	–
2	–
3	–
4	CAN L (low)
5	CAN H (high)
6	–
7	CAN GND (ground)
8	–

CAN interface

The integrated CAN interface is designed in accordance to DS 301 and 401 for a flexible use in different places and tasks in the CAN bus network. All Sontheim CAN interfaces comply to ISO 11898.



mSiEcomTCtt

mSiEcomTCtt extends the Sontheim product portfolio with an extremely compact Computer-on-Module. It has an Intel Atom processor and various interfaces. Thanks to the extended temperature range of -40°C to $+85^{\circ}\text{C}$, the module is also ideal for the use in harsh environments.

Key Features



COM Express mini, Type 10



Intel Atom E6xx (600 MHz, 1 GHz, 1.3 GHz and 1.6 GHz)



Onboard 10/100/1000 Mbit LAN



1× CAN interface acc. to ISO 11898



6× USB 2.0



3× PCI Express



Also suitable for harsh environments due to increased temperature range

Variety of interfaces and scalable performance

Beside six USB 2.0 interfaces, the mSiEcomTCtt has one CAN channel. Furthermore, Ethernet and also I²C for controlling peripheral components are integrated. The chip sets are ranging currently from 600 MHz up to 1.6 GHz with an Intel Atom. Depending on the requirements up to 2 GB DDR2-800 RAM can be used, thereby also intensive tasks are possible with low power consumption.

Compact form factor

Due to the compact design (COM Express mini, Type 10), the mSiEcomTCtt can be mounted as a piggy-back variant onto another PCB and is ideally suited for the development of small devices, profiting from the high degree of standardization and scalability of the COM Express standard. Especially for mobile embedded hand-held systems as well as for small portable, stationary and in-vehicle devices that are used in various application areas, the mSiEcomTCtt is the perfect solution.

Technical Data

CPU	Intel Atom E6xx (600 MHz, 1 GHz, 1.3 GHz and 1.6 GHz)
Cache	512 KB L2 Cache
Chipset	Intel Platform Controller Hub EG20T
RAM	up to 2 GB DDR2-800 RAM
CAN interface	1x CAN 2.0 B active, up to 1 Mbit/s
USB	6x USB 2.0
Ethernet	10/100/1000 Mbit LAN
Interface	GPIO on COM Express Connector
SPI/SM Bus Support	External Boot via SPI flash device / SM Bus Support yes
PCI Express	3x PCIe
SATA II	2x
UART	1x
Audio controller	Intel® High Definition Audio
Graphic controller	integrated 2D/3D Graphics Engine, Gfx Core 333/400 MHz, shared VRAM Video Encode: MPEG4, H.263, H.264 Video Decode: MPEG2, MPEG4, VC1, WMV9, H.264
Resolution	LVDS 18/24 bit 1280x768 @60 Hz SDVO 1280x1024 @85 Hz
Operating system	Windows XP, XP embedded, 7, embedded 7, Linux
Dimensions (l×w)	55 mm × 84 mm, COM Express mini, Type 10
Storage temperature	−30 °C up to +85 °C, extended −40 °C up to +85 °C
Operating temperature	0 °C up to +60 °C, extended −40 °C up to +85 °C
Rel. humidity	Operating: 10 % up to 90 %, Storage: 5 % up to 95 % non-condensing
Power supply	5.2–5.8 Watt @5 V

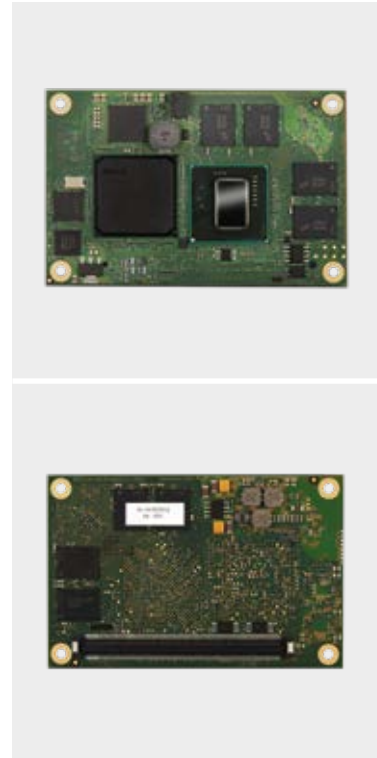

Designed for commercial and industrial temperature range

In addition to the normal temperature range the module is also suitable for the extended industrial temperature range (E2) from −40 °C to +85 °C. This opens a wide range of applications in the automotive-, automation-, medical technology, and in other work environments which are not matching the commercial temperature range.

mSiEcomTCtt and our embedded PC – a reliable combination

You are looking for the appropriate embedded platform for your automation application. Combine mSiEcomTCtt with our ePC and benefit from our know-how and the full service from the expert

- Variety of interfaces (modular design)
- IP20 metal housing for a high EMC protection
- Use as a PLC, CAN bus master or slave, signal processing center and much more.
- Suitable for industrial use
- Passive cooling

Order information

V970005000	mSiEcomTCtt
------------	-------------



i.MX 6

The ultra-energy-saving Computer-on-Module offers an optimal price performance ratio. Scalable building blocks facilitate customized mobile and cross-linked embedded solutions based on ARM technology.

Key Features



Freescale i.MX6 (Single, Dual, Quad Core, 800 MHz up to 1.2 GHz)



Up to 4 GB DDR3 memory



Onboard 10/100/1000 Mbit LAN



Numerous interfaces, e.g. 3× USB 2.0, 3× PCIe



Extended temperature range



Evaluation board on-demand

Scalable performance and compact form factor

The i.MX 6 board from Sontheim is based on a 314-pin MXM 3.0 connector and a size of 82 mm × 50 mm. This creates extremely compact, durable and cost-effective development potentialities for mobile embedded hand-held systems as well as little portable, stationary and in-vehicle devices that can be used in various application fields.

Designed for commercial and industrial temperature range

Beside the standard, the i.MX 6 board is ruggedized for an extended industrial temperature range from -40°C up to $+85^{\circ}\text{C}$. This leads to various applications in the automotive sector, in automation, medical technology and further work environments that don't correlate the commercial temperature range and involve harsh environmental conditions. Furthermore, an evaluation board is available on request.

Technical Data

CPU	Freescale i.MX6 Single, Dual and Quad Core ARM Cortex-A9 800 MHz, 1 GHz and 1.2 GHz
Graphic	Dual Display HD 1080p encoded and decoded 2D and 3D Speed-up
RAM	DDR2 or DDR3 up to 4 GB
Memory	up to 64 GB NAND/eMMC on-module (customized)
USB	3x USB 2.0
Ethernet	10/100/1000 Mbit LAN
Display	Parallel LCD 18/24 bit LVDS single channel 18/24 bit HDMI
Image Capture Interface	2 interfaces (PCAM, CSI)
Serial interfaces	2x RX/TX (Ser 1/3); 2x UART (Ser 0/2)
Further interfaces	up to 3x PCIe, MLB150, 12x GPIOs, SDIO, SATA eMMC, 2x SPI, 5x I ² C, 2x I ² S, SPDIF WDT, 2x CAN, battery and system management
Operating system support	Linux Windows embedded compact 7 (on request) Android (on request)
Operating temperature	0°C up to +60°C, extended range: -40°C up to +85°C
Dimensions	SMARC standard: 82 mm x 50 mm



IO features of the 314-pin MXM 3.0 connector



Evaluation board



Supported operating systems

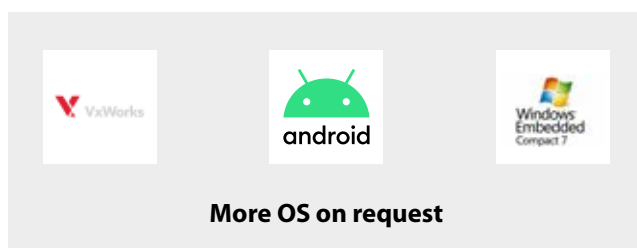

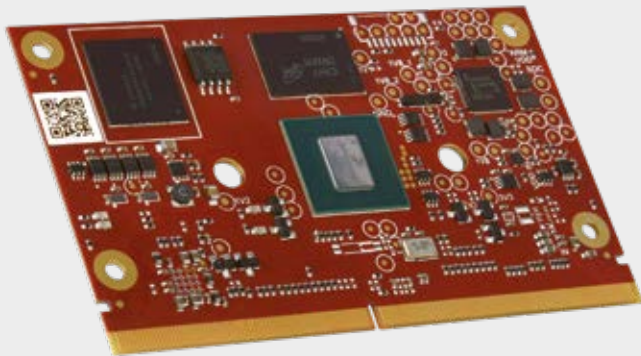

i.MX 8

The i.MX 8 family offers an optimal price-performance ratio. Scalable building blocks enable customized embedded solutions based on ARM® technology. Thanks to an integrated neural processing unit, the i.MX 8 offers the best conditions for AI and ML applications and is optimized for telemetry applications.

Key Features



Freescale i.MX 8 (Dual Core, Quad Core, 1.2 GHz – 1.8 GHz)



Up to 8 GB DDR4 memory



On-Board 10/100/1000 Mbit LAN



Variety of interfaces, e.g. 3× USB 2.0, 3× PCIe



CAN and CAN FD



Extended temperature range



Optimized for AI and ML applications



Optimized for telemetry applications



Evaluation board on-demand

Scalable performance and compact form factor

The i.MX 8 board from Sontheim is based on a 314-pin MXM 3.0 connector with standard dimensions of 82 mm × 50 mm. This creates extremely compact, durable and cost-effective development options for mobile embedded handheld systems as well as small portable, stationary and in-vehicle devices that can be used in a wide range of application areas. The i.MX 8 is available in two variants. The i.MX 8M Plus variant for high performance applications, optimized for AI and ML applications and the i.MX 8X Lite variant for high performance telemetry and industrial applications. The i.MX 8X Lite variant has been specially optimized and developed for the Sontheim telemetry series COMhawk® xt.

Designed for commercial and industrial temperature range

In addition to the normal temperature range, the i.MX 8 board is also designed for the extended industrial temperature range of –40 °C to +105 °C – the i.MX 8X Lite variant even up to +125 °C (AEC-Q100 Grade 2 device). This opens up a wide range of applications in the automotive sector, in automation, in medical technology and in other working environments that do not correspond to the commercial temperature range and involve harsh environmental conditions. In addition, an evaluation board is already available on request.

Overview of the target applications

Industrial:

Control systems, architectures with time-critical networking, Ethernet or CAN networks, HMIs and IPCs, robot controllers, printing systems, industrial handheld devices, intelligent industrial cameras and much more.

Automotive

High-performance telemetry and vehicle gateways, camera systems, vehicle interfaces (VCIs), ECUs, data loggers with analysis (AI), joysticks, displays and much more.

Optimized for machine learning and AI applications

The i.MX 8 board from Sontheim features an integrated neural processing unit (NPU) that delivers up to 2.3 TOPS (Tera Operations Per Second). This gives the board a processor that is used exclusively for machine learning and enables compute-intensive AI applications. As a result, the ML/KI application no longer needs to be moved to the cloud, but can run directly on the i.MX 8 processor – personal user data is also better protected as a result. Applications such as the recognition of multiple complex neural networks, human poses and emotions, or the monitoring of multiple objects are thus possible.

Technical data

	i.MX 8M Plus	i.MX 8X Lite
CPU	Freescale i.MX 8 Quad Core ARM Cortex-A53 1.8 GHz	Freescale i.MX 8 Dual Core ARM Cortex-A35 1.2 GHz
MCU	Freescale Cortex-M7 800 MHz	Freescale Cortex-M4F 170 MHz
RAM	up to 8 GB 132-bit DDR4	up to 1 GB 16-bit LPDDR4
GPU	GC7000UL (2 shaders), OpenGL ES 1.1/2.0/3.0/3.1, OpenVG 1.1, Vulkan, OpenCL 1.2; GC520L (2D)	–
NAND Flash	up to 64 GB eMMC (on-module)	up to 8 GB eMMC (on-module)
Security	CAAM, RDC, Trust Zone	Trust Zone
AI/ML	Neural Processing Unit 2.3 TOPS	–
Camera	2× MIPI CSI (4-lanes each) 2× ISP up to 12 MP resolution	–
Display	HDMI 2.0a Tx, MIPI DSI (4-lanes) LVDS (4/8-lanes)	1× Parallel Display
Video Decode	1080p60 HEVC, H.264, VP9, VP8	–
Video Encode	1080p60 H.265, H.264	–
Audio	18× I2S TDM (32 b @ 384 kHz), ASRC, 8-ch. PDM DMIC input, eARC	–
Interfaces	2× GbE (1× TSN), 2× CAN/CAN FD 3× SD/eMMC, Raw NAND 2× USB 3.0/ 2.0 5× UART, 6× I ² C, 3× SPI, 1× PCIe 3.0	2× GbE (1× TSN), 3× CAN/CAN FD 3× SD/eMMC, Raw NAND 2× USB 2.0 4× UART, 3× I ² C, 3× SPI, 1× PCIe 3.0
Package	LFBGA-548	BGA-388
Operating system support	Linux	Linux
Operating temperature	0°C up to +95°C, extended range: –40°C up to +105°C	–40°C up to +105°C, extended range: –40°C up to +125°C
Dimensions	SMARC Standard: 82 mm × 50 mm	SMARC Standard: 82 mm × 50 mm

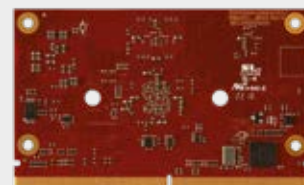



SMC100

SMC100 is a stepper motion controller for bipolar 2-phase stepper motors. Similar to MC105 the controller offers some functions for configuration and safety. You will benefit from an integrated logic module for configuring and saving operating data.

Key Features



Control of two bipolar 2-phase stepper motors



Phase current of up to 10 A



Four galvanically isolated in-and outputs



1× CAN interface acc. to ISO 11898



Own intelligence for self regulation and data management



Free configuration and storage operating data



Compact housing with IP20 and integrated top hat rail mounting

Housing

The compact housing is made of aluminium. It contains a top hat rail mount and a front cover with all interfaces for better overview in the control cabinet. The technician will note the convenience while working at the bus cabling. You can also set module address and baud rate in short time via DIP switch.

Stepper motor

All connected stepper motors are current-controlled. Either 24 V or 48 V stepper motors with up to 10 A can be dealt with. The current in each phase is separately controlled. Finally, standby current can be adjusted to the nominal current between 0 and 100 %.

Technical Data

CPU	Texas Instruments TMS320 DSP
Fieldbus	CANopen acc. to DS 402
Interfaces	4× DI / 4× DO, galv. isolated, optional 1× encoder interface
Operating modes	1/1, 1/2, microstep
Operating system display	1× LED green for supply voltage (5 V) 1× LED green for operating mode (run) 1× LED red for error status (err)
Dimensions (l×w×h)	115 mm × 45 mm × 118 mm
Housing	Aluminium housing with protection class IP20
Storage temperature	−10 °C up to +70 °C
Operating temperature	0 °C up to +60 °C
Rel. humidity	90% non-condensing
Power supply	24 V DC / 48 V DC
Supply of the motors	isolated, 24 V / 48 V DC up to max. 10 A

Operation modes

You can switch between full, half and micro-step. There is an incremental encoder with a resolution of 16 bit available as well.

Safety first

The current limit can be configured and saved as a basis value, avoiding errors in the calculation. Like all our controlling devices SMC100 also contains an emergency-stop function which is activated as soon as it registers a lack of bus communication.

Order information

V966295400	SMC100
------------	--------

Pin assignment



CAN D-Sub9

1	–
2	CAN low
3	CAN GND
4	–
5	–
6	–
7	CAN high
8	–
9	–



DIP switch

0	10
1	20
2	50
3	125
4	250
5	500
6	800
7	1000



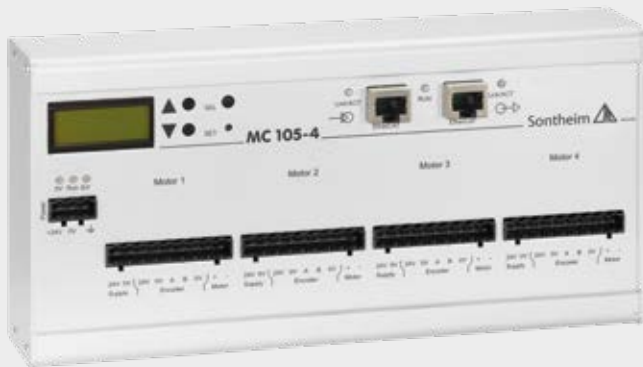

MC105

MC105 is a motion controller for up to four DC motors. It has various configuration options and security functions for extremely high ease of use. An integrated logic module automatically sets and saves all relevant operation data. The motors are all current controlled. It is possible to handle 24 V DC motors with up to 5 A via incremental encoder with a resolution of up to 12 bit.

Key Features



Own intelligence for self regulation and data management



Safety features for high operating safety



Free configuration and storage of operating data



Compact housing with IP20 and integrated top hat rail mounting

Functions of the channel

One motor can be controlled per channel. One encoder and one power supply per channel are available. Current limitation and current measurement can also be performed individually

Safety is a top priority

The limit current is definable and is stored by the module as a base value, thus avoiding errors in the current calculation. The MC105 additionally has an emergency stop function, which is triggered in the absence of bus communication.

Technical Data

CPU	Philips Arm 7
Fieldbus	EtherCAT
LEDs	1× LED green for power supply 1× LED green for operation mode (Run) 1× LED red for error (Err)
Display	2 lines à 16 signs
Dimensions (l×w×h)	241 mm × 120 mm × 48 mm
Weight	approx. 800 g
Housing	Aluminium housing wit protection class IP20
Storage temperature	-10 °C up to +70 °C
Operating temperature	0 °C up to +60 °C
Rel. humidity	90 % non-condensing
Supply of the motors	isolated, 24 V DC up to max. 5 A
Power supply	24 V DC

Pin assignment



RJ 45

1	TX+
2	TX-
3	RX+
4	-
5	-
6	RX-
7	-
8	-



9-pole phoenix connection

1	24 V (supply)
2	0 V (supply)
3	24 V (Encoder)
4	0 V (Encoder)
5	A (Encoder)
6	B (Encoder)
7	0 V (Encoder)
8	+ (Motor)
9	- (Motor)

Order information

V966295000	MC105-4 EtherCAT
------------	------------------



EvoPrint®

Our future-oriented product portfolio allows the integration of the EvoPrint® printing system into existing processes without any difficulties. This includes digital and analog IO modules, hydraulic valve controls, drive technologies, PLCs and scalable industrial PCs with integrated fieldbus interfaces.

Key Features



Printing during positive or negative acceleration



Active speed compensation



Software and firmware updates in the field via LAN



HP Inkjet Technology



Robust aluminium housing

The request

Are you looking for an industrial printing system that can be quickly, easily and fully integrated into your production processes? Do you want professional printing results, regardless of the materials used and the printing speed?

The situation

Most suppliers of HP Inkjet Technology printing systems are offering solutions, that are extremely difficult to integrate into existing production processes. They often require a separate space between two steps and additional time for the printing. Moreover, there are only few possibilities to integrate controls and the user interface into existing control systems. Common systems are sold with an extra PC-based interface – which requires room, money and specially trained operators!



Functional design meets comfortable handling, which allows an easy change of cartridges

The elegant solution

EvoPrint® provides seamless integration of an industrial printing system into an existing machine without changing the production line. With a maximum print speed of up to 180 m/min or 3 m/s at 300 dpi resolution, EvoPrint® is thus considerably faster than conventional printing systems. Even during acceleration, precise printing is still possible. Furthermore, active speed compensation avoids rupture and warp, while the direction detection eliminates double printing. You will save process time and material costs! EvoPrint® offers software tools, which can be fully integrated into existing customer interfaces without the need for an extra PC-based interface in the machine. The printing system itself is connected by standard LAN/Ethernet for image transfer. The control can be done by fieldbus like EtherCAT or CAN as well as LAN or incremental encoders.

Application areas

EvoPrint® is tested and approved in practice. Due to the close cooperation with our customers in combination with our outstanding know-how as a system integrator, we provide individually tailored system solutions for various branches of industry:

Wide area of expandabilities

- Performance resources even at complex applications
- 32-bit microprocessor with 200 MHz
- 64 MB RAM and 32 MB Flash on board

Customizable applications

- No change of production line
- Assembly at static or moving axes
- Printing of text, 1D & 2D barcodes and images

Highest quality

- 300 dpi at a printing speed of 180 m/min
- Active velocity compensation
- Course detection
- Based on HP Inkjet Technology

Future-proof due to innovative technology

- EtherCAT and CAN, standard-ethernet and incremental encoder
- Software tools for integration into existing application software

Technical Data

CPU	Powerful 32-bit microcontroller with 200 MHz clock frequency Fast FPGA to control the cartridges
Storage	32 MB Flash, 64 MB RAM on board
Connections	1x RJ45 LAN 100 Mbit IEEE 802.3 2x RJ45 (EtherCAT or CAN), 2x Incremental (Encoder) Interface (D-Sub9) 1x Supply voltage 9-pole phoenix 4x Digital outputs (Ub -0.5 V) 1x RS232 (D-Sub9)
Control panel/membrane keyboard	4 navigation keys for menu operation, 6x status LEDs for EtherCAT/CAN and LAN
LCD	LCD display with 2x 8 characters for device status, error code display, filling level alarm
Speed	Maximum print speed up to 180 m/min at 300 dpi resolution
Print distance	< 2 mm
Print height	max. 5 cm in one print process
Installation options	Static or moving axes
Number of cartridges	4x HP Inkjet Technology
Supported cartridges	C8842A versatile black, Q2344A SPS1918 DYE Black C6168A, C6169A, C6170A and C6173A Spot Color (red, green, blue and yellow) VP90-E (UV curing), others on request
Average droplet size	26–29 pl (depending on the ink used)
Bulk system management	Supply via 1 of 2 bulk tanks for continuous printing of large jobs
Cartridge management	Cartridge calibration (pre-warming, spitting, pulse width, voltage)
Software	Various software tools for configuration and integration into existing applications Easily programmable 32-bit API (DLL)
Features	Printing during positive or negative acceleration Active speed compensation (no warping or tearing of the printed image!) Direction detection (positive, negative) Software/Firmware Update in the field via LAN Dust protected
Dimensions (l×w×h)	187 mm × 114 mm × 218 mm
Protection class housing	IP52
Weight	approx. 3.3 kg
Rel. humidity during printing	10 % – 80 % non-condensing
Rel. storage humidity	10 % – 80 % non-condensing
Operating temperature during printing	+10 °C up to +40 °C
Storage temperature	+10 °C up to +30 °C
Power supply	30 V DC (±5 %)

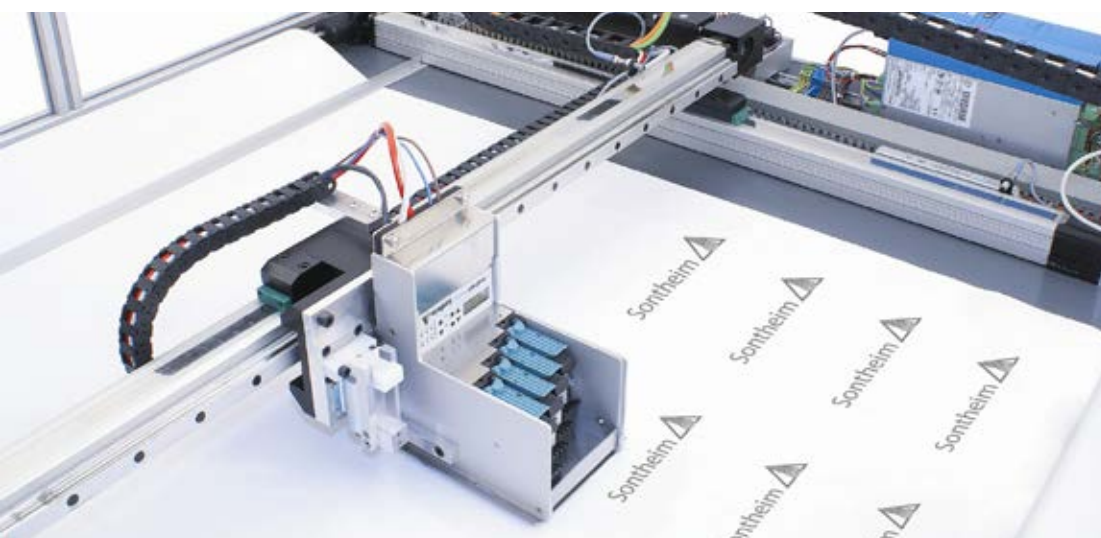

Sample application: EvoPrint® in motion. Assembled at a moving axis on a xy-plottertable.



Production

The Sontheim company has been producing the broad portfolio in-house since its foundation and thus has full control over quality and production processes. We cover the entire product life cycle, including the design and development phase, production, and integration and support. This contributes to very close customer support and enables fast and agile responses. The range of services includes individual prototypes, series deliveries and customized solutions.

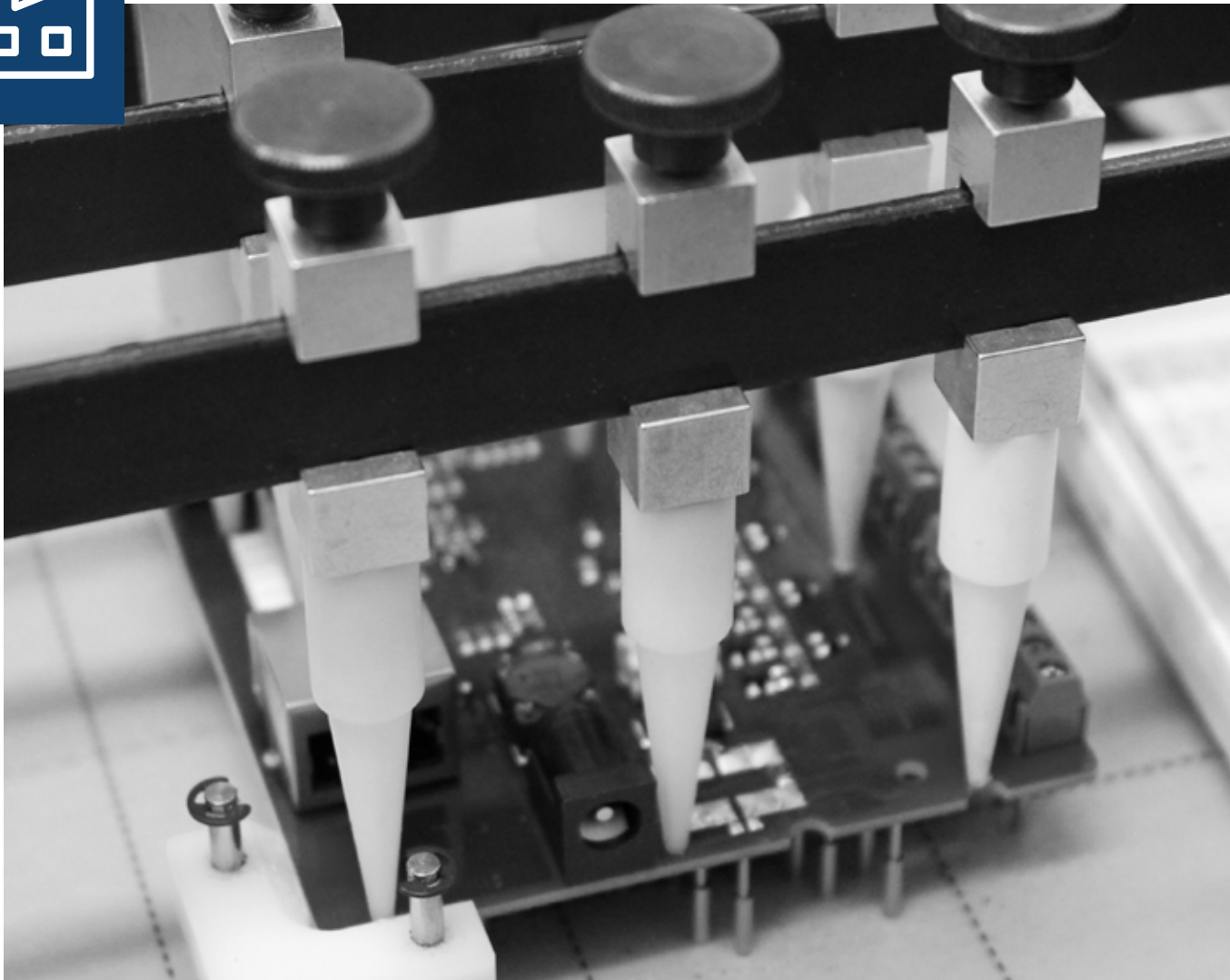

Diagnostics

Visualization and Monitoring











MDT[®] 2.0

The Modular Diagnostic Tool 2.0 offers an OPC UA server and client in addition to ODX and OTX standard. This ensures comprehensive and simple operability, which is additionally supported by Visual Studio[®].

Key Features

-  **OPC UA server & client**
-  **ODX acc. to ISO 22901-1**
-  **OTX acc. to ISO 13209**
-  **Multi platform support**
-  **High-performance runtime system**

Innovative machine park monitoring – based on standards

The new MDT[®] 2.0 is a standardized tool to access data of the machines. It enables the standardization of the data description (ODX), the programming (OTX) and the sharing & provision of the data (OPC UA). With the MDT[®] 2.0 tool chain, you have various options for creating, structuring and implementing test bench workflows, based on the industry standard OTX (Open Test Sequence eXchange format) according to ISO 13209, while the ODX 2.2.0 standard (Open Diagnostic Data Exchange) guarantees reusability of test bench services. Thanks to the platform-independent OPC UA architecture, the information obtained can be transmitted to a supervisor and thus integrated in the entire environment.

Multiplatform support – one workflow for all end-use applications

The extremely lean runtime system is designed specifically for multi-platform applications and provides GUI support as well as a platform-independent description of the runtime workflow language. This reduces both implementation and testing efforts for your applications across multiple PC, mobile or embedded platforms. In doing so, the MDT[®] 2.0 allows you to create your test bench control once and run it on a wide variety of environments such as Windows, Linux x86, Linux ARM or QNX without any customizations.

Modern design and new graphic modules

A new, clean and modern design allows the use of Visual Studio plug-ins, for example for SVN or Git. New graphical elements such as 2D and 3D animations can be used to create your diagnostic application. The diagnostics are thus more visually appealing and the intuitive usability for the service personnel and the diagnostic user is once again significantly increased..

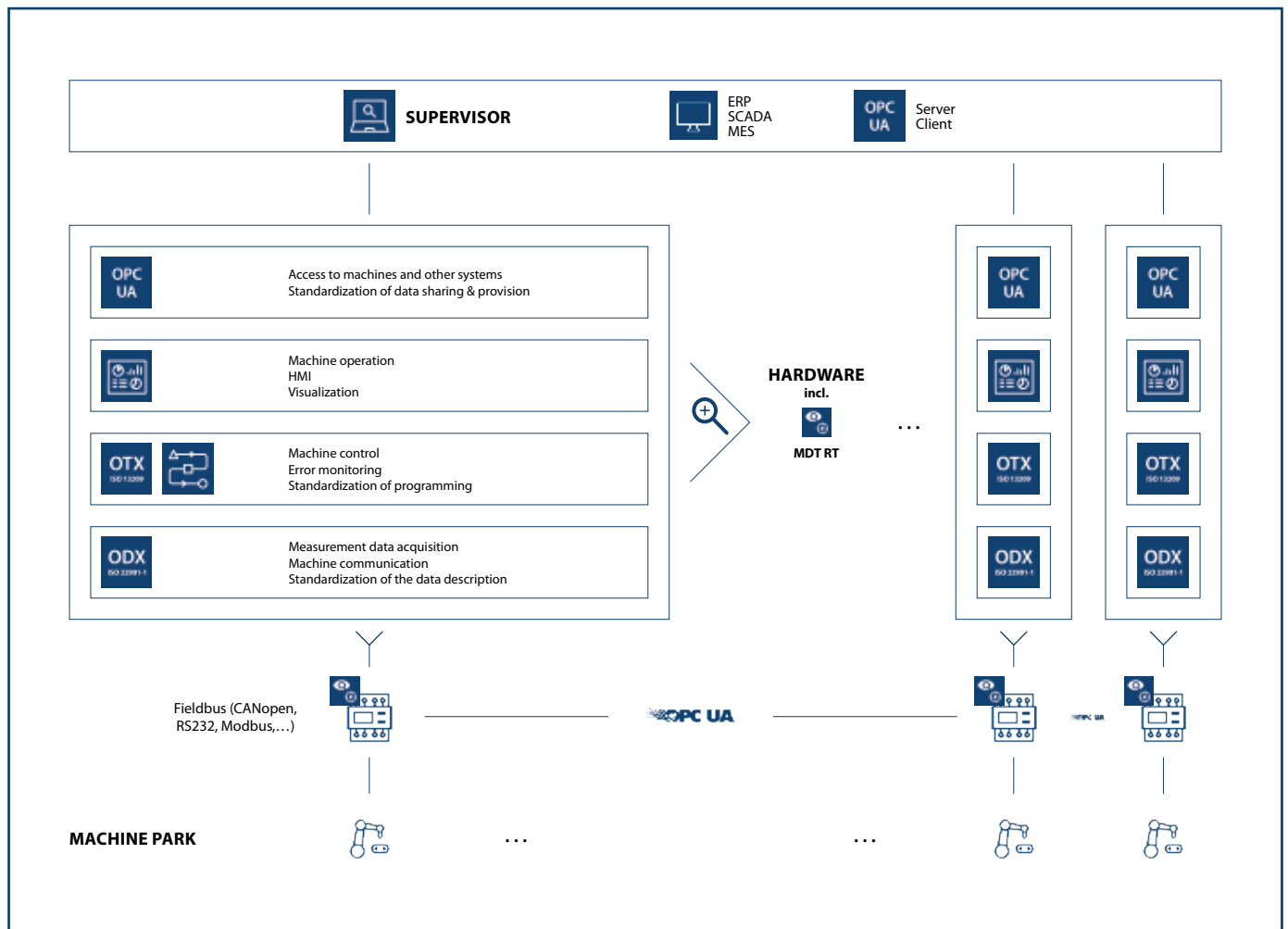
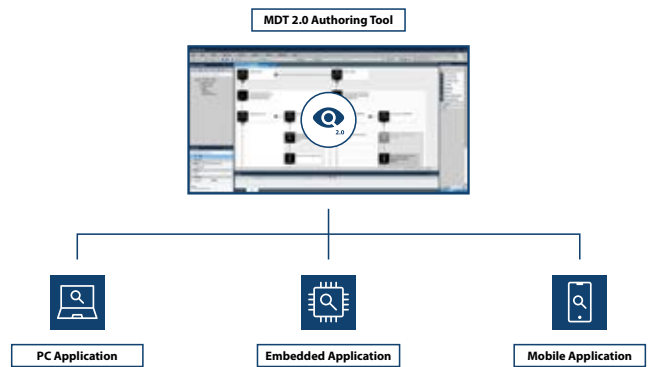

Order information

V940800300	MDT® 2.0 Authoring system
C940800300	MDT® 2.0 Authoring system maintenance

CANexplorer 4



Modular, intuitive, efficient – CANexplorer 4 is a completely new developed field bus-analyzing software which represents the huge know-how in working with CAN networks in complex machines and vehicles. The new generation obtains a significantly enhanced range of functions and an improved handling. This makes the CANexplorer 4 a very intuitive and powerful tool.

Key Features



User-defined measurements setups with graphic elements and Drag and Drop



Receive, edit, transmit and abstract raw data



J1939-protocol support



CANopen-protocol support



Modular design with expansion options



Import and export from signal databases

Data processing

CANexplorer 4 offers various functions for processing CAN data, e.g. classical text-based traces, graphs, bar graphs, LEDs, filters and triggers. Generating a test set-up can be carried out by connecting different functional elements via Drag and Drop. This enables the software to consequently display complex processes in a visual and common manner.

Visualization

You can adapt the data visualization by defining triggers and filters. It is also possible to take an active part in the bus communication and generate and transmit messages that are also shown in a visualization. Have your telegrams sent manually, fully automatic or via trigger.

Data abstraction

Use an integrated protocol abstraction for automatically interpreting data to CANopen and J1939. The CAN data is then available as pre-processed and readable information. Further protocol stacks can easily be added with updates. All proprietary protocols and RawCAN data can be processed with a manual symbol editor. This tool is used for defining symbols and translating the payload of a CAN frame into comprehensible values.

Parallel processes

CANexplorer 4 obtains a multi-thread support for parallel usage next to other applications running on a PC and the visualization of various modules at the same time.

Overview of the most important modules:

Input:

CANexplorer 4 obtains various possibilities for manually or automatically creating CAN data as well as reading CAN messages at the bus.



Signal generator Transmit

Creation of signal processes.
Fast access to pre-defined CAN messages.



Replay

Replay of previously recorded CAN log-data for an analysis of the CAN bus data.
It is possible to apply original time-settings of the records.



Hardware Inputs

Receiving and transmitting of CAN data. All Sontheim interfaces are supported, e. g. CANUSB, CANUSBlight and PowerCAN.

Processing:

Different filters provide a comfortable handling of the various CAN data. Moreover, the user can abstract the data to J1939 and CANopen.



Filter

One can use filters for CAN identifier, areas of CAN identifier, data bytes and message types. The filters have a positive and a negative output.



Protocol Filter

The integrated filters J1939 and CANopen offer an abstraction and pre-processing of CAN bus data traffic.



Trigger

Creation of an event which can start a pre-defined operation. The user can choose between different triggers (e. g. data bytes or data bits) for a maximum of flexibility.

Visualization And Recording:

The modular-based design of the CANexplorer provides individual adaptation of the visualization and the display of specifically required data. The CAN bus traffic can be recorded and visualized easily via different elements. Of course, the various instruments can be chosen and configured according to the user's requirements.



Log Module

Easy writing of CAN messages into a log-file.



Trace

Tabular display of CAN messages in the static or trace mode.



Graph

Visualization of signals via graphs. Underlining events via placing of markers.



Signal Monitor Symbol Editor Bar-Graph Statistic

Display of signals in a table, including minimum and maximum. Definition of symbols down to the Bit layer for a simplified and more lucid illustration of CAN information. Visualization of signals via bar-graphs or tachometer. Indication of bus statistics (e.g. amount of received / transmitted messages, bus-charge and others).

Technical Data

Operating system	Windows 2000 SP4, XP, Vista (32-Bit), 7, 8, 10
CPU	1.6 GHz Intel Pentium
RAM	512 MB
Graphics	1024x768 px, 16 mio. colors
Minimum hard disk space	min. 80 MB
Supported CAN Hardware	COMfalcon® CANUSB CANfox® CANUSBlight PowerCAN-PCI V1 and V2 PowerCAN-PCI04+ PowerCAN-PCI04 V2 Other CAN hardware available upon enquiry

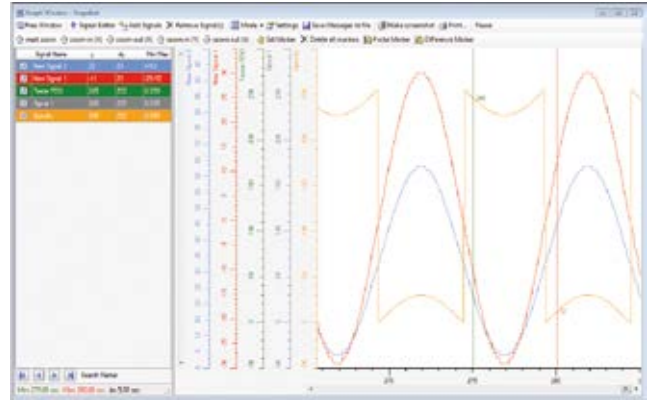

Features

Receiving and transmitting CAN messages	Signal generator with different signals (sinus, saw tooth, rectangle) Manual transmitting of definable CAN messages Cyclic transmitting of definable CAN messages Transmitting in block mode
Filter	CANexplorer 4 supports filtering for identifier, data bytes, symbols and message types
Trigger	Canexplorer 4 uses pre- and post-trigger
Signal database	Saving of messages in a database as well as visualization via texts and graphic elements for intuitive handling Editor for generating and processing of signals (message, multiplexer, key, groups and signal) For both data import and export there are various data types supported
Visualization	Trace, graph, bar-graph, tachometer, symbol-monitor
Data processing	Writing in log-file, replay mode
Protocol support	RawCAN, CANopen, J1939, implementation of proprietary protocols upon enquiry
Bus statistic	Overview of transmitted and received messages bus-charge and CAN levels
Quick Trace	Quick monitoring of the CAN channels without previous creation of a test setup

Order information

V940340010	CANExplorer 4 Basis
V940340099	Software maintenance
V940340020	Extended graph
V940340021	Extended measurement setup
V940340022	BarGraph & Tacho, LED
V940340023	Protocol filter J1939
V940340024	Protocol filter CANopen
V940340025	Signal-generator
V940340026	DBC-import & export
V940340027	ASC-support
V940340029	Vector-support for CANcardXL
V940340030	Peak-support for PCAN-USB



Custom Developments

As an expert in various fieldbus technologies, we would be happy to support you with customer-specific developments in the area of software, hardware, firmware, as well as the design and conception of your automation or automotive solution. Here you benefit from our holistic know-how as a system provider and the perfect interaction of functional hardware and suitable firmware up to the modular and optimized software.



Connectivity

IoT-Gateways, Interfaces, Cloud Software





eSys-IDC4E1



eSys-IDC4E1 enables the connection of different CAN buses via IP networks. The high-performance CAN-to-Ethernet gateway provides a LAN connection and four galvanically isolated CAN interfaces. In addition, the module provides various measurement and diagnostic functions in machine fieldbus systems.

Key Features

32
bit

Powerful 32-bit CPU



1× Ethernet, 10/100 Mbit/s

CAN

4× CAN acc. to ISO 11898, galv. isolated



Active resistance measurement



Integrated error frame detection



Robust aluminium housing

J2534

Including standardized SAE J2534 interface

CAN-to-Ethernet gateway with integrated diagnostic functions

In addition to four galvanically isolated CAN channels eSys-IDC4E1 provides an Ethernet connection for the transmission of data to a higher-level computer. For CAN bus monitoring an active resistance measurement and an error frame detection is implemented. This feature allows surveillance and monitoring of a CAN network. eSys-IDC4E1 possesses an own logic for detecting error frames and counting them up in a specific internal memory area. Thus is used for finding intermittent errors like the falsified messages of a CAN participant.

Standardized SAE J2534 API

The Sontheim pass-thru API is supplied as a standard interface with eSys-IDC4E1. Thus, the module can be used for applications based on J2534. Further higher level protocols can be easily implemented on demand.

Software architecture

The software architecture of the CAN module consists of a host device structure in which a x86 PC-system as a hosts use the module as a device for access to the CAN bus. For communication between host and device Ethernet is used. The communication takes place via IP and a proprietary, on UDP based communication protocol. For identification (Discover) of the CAN interfaces over

Technical Data

CPU	Freescale PowerPC, 400 MHz
RAM	32 MB (optionally up to 128 MB)
Memory	16 MB (optionally up to 128 MB)
CAN interface	4× CAN interface galv. isolated, according to ISO 11898 Standard, 2.0 A and 2.0 B
Baud rates	50 Kbit/s up to 1 Mbit/s (incl. 800 Kbit/s)
CAN termination resistance measurement	Measurement of the terminating resistor of the CAN bus of the machine; measurement takes place with active bus
CAN diagnostic	Error frame detection
CAN connections	4× D-Sub9
LAN	100 Mbit LAN, RJ45 connection
LEDs	LAN Status LED, green and yellow at RJ45 connection
Others	Can also be used as CAN-to-CAN bridge
CE-Sign	EN 61000-6-2 electromagnetic compatibility (EMC) Interference immunity (10V/m) EN 61000-6-4 electromagnetic compatibility (EMC) Interference emission EN 61000-4-2 immunity to static discharge (ESD) EN 61000-4-3 immunity to radio-frequency electromagnetic fields EN 61000-4-4 immunity against fast transient electrical disturbances EN 61000-4-5 interference immunity against surge voltages EN 61000-4-6 immunity to conducted disturbances induced by high-frequency fields
Dimensions (l×w×h)	approx. 121 mm × 151 mm × 48 mm – without connection
Housing	Aluminium housing, Protection class IP30
Storage temperature	–20 °C up to +70 °C
Operating temperature	0 °C up to +60 °C
Supply	24 V ±10 % / max. 1 A

LAN, the process according to ISO 13400 is used. The firmware of the CAN module is composed of a main thread, which handles the CAN communication and is also able to handle the transport layer communication protocols (e.g. J1939-21/J1939-81, ISO 15765), and a diagnostic thread for a self- and CAN diagnostic. All non-related services to the direct communication of the CAN module, such as the configuration of the bridging or CAN diagnostics are handled over the so-called “tool-box” protocol. The order of the received message at the host interface is the same order as on the physical bus, regardless whether the message was sent or received. Thus, an extremely high-performant communication is guaranteed at low latency.

Order information

V930230300

eSys-IDC4E1

Pin assignment

CAN D-Sub9



2	CAN low
3	CAN GND
7	CAN high

LAN-RJ45



1	Tx+
2	Tx–
3	Rx+
4	–
5	–
6	Tx–
7	–
8	–

CAN resistance measurement



1	120Ω CAN1 On/Off
2	120Ω CAN2 On/Off
3	120Ω CAN3 On/Off
4	120Ω CAN4 On/Off

Phoenix connection



1	24V
2	0V
3	PE

Block diagram

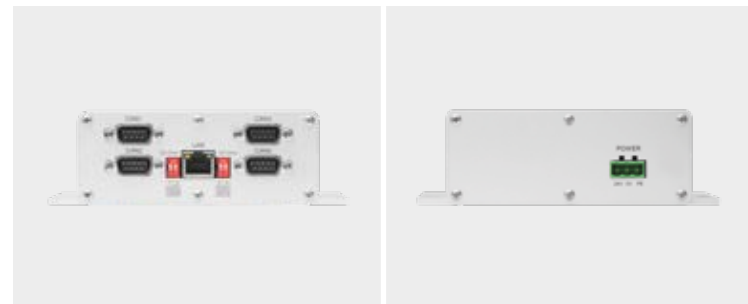
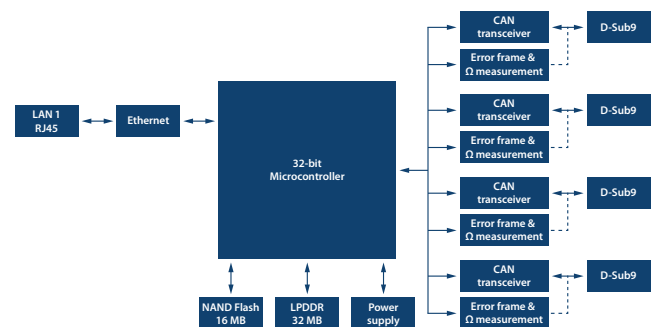



COMfalcon®

COMfalcon® is a powerful CAN interface with WLAN/LAN interface and various equipment options. Use it for monitoring, flashing or analyzing CAN networks and handling layer-7 protocols like CANopen or SAE J1939. It is a very flexible and easy to use tool for the detection of CAN data and monitoring of entire networks.

Key Features

- CAN
4× independent CAN channels
- WLAN
WLAN interface
- ✓

RS 232
 RS 422
 RS 485
- K-Line
K-Line
- ☑
Protocol handling
- 📄
Optional with data logging, scripting, CAN voltage level oscilloscope functionality
- SD
Optional with integrated SD card
- IP
Compact housing with protection class IP65

Housing and status indicators

The device has a fairly rugged housing built of aluminium with IP65 protection. Thanks to the compact design and high shock resistance, COMfalcon® can be used for various automation applications. Two 14-segment displays and nine LEDs are always showing the current status/error code of the device.

Interfaces

The COMfalcon® has four independent CAN channels and is based on the CAN interface CIN with a Freescale PowerPC architecture. WLAN/LAN (infrastructure mode) is used to connect to a diagnostic laptop/PC. In addition to the CAN interfaces a various of other interfaces such as RS232, RS422, RS485 or K-Line are available for diagnostic purposes.

Error frame detection

This feature allows surveillance and monitoring of a CAN network. The COMfalcon® possesses an own logic for detecting error frames and counting them up in a specific internal memory area. That is used for finding intermittent errors like falsified messages of a CAN participant.

Technical Data

CPU	Freescale PowerPC
RAM	64 MB
Memory	16 MB (for data logging optionally up to 128 MB)
CAN interface	4× CAN interface acc. to ISO 11898
Baud rates	50 Kbit/s up to 1 Mbit/s
CAN termination resistance measurement	Terminating resistor of the vehicle CAN network with active bus
CAN Port	2× 7-pole M16 port (like Sontheim CANUSB-2)
RS232 interface	D-Sub9 Plug A
Serial multiplex interface	D-Sub9 Plug A; 5 different serial interfaces, changeable via software
K-/L-Line interface	K-/L-Line (acc. to ISO 9141-2, ISO 14230-4), Baud rate up to 56 kBaud/s
RS485 interface	EIA/TIA-485 compatible Baud rate up to 10 Mbit/s no integrated termination resistor
RS422 interface	ANSI/TIA/EIA-422 compatible Baud rate up to 10 Mbit/s no integrated termination resistor
LAN	M12 4-pin female connector 100 Mbit/s LAN, D-codiert
WLAN	1× acc. to IEEE 802.11g, up to 54 Mbit/s
14-segment display	Boot information, K-line mode, RS-mode, measurement, error codes
LEDs	Power LED (green) LAN status LED (green and yellow) WLAN status LED (green and yellow) 4× CAN status LED (green and yellow) 2× RS status LED (green and yellow)
Dimensions (l×w×h)	110 mm × 150 mm × 35 mm
Housing	Aluminium, protection class IP65
Storage temperature	−40 °C up to +85 °C
Operating temperature	−20 °C up to +60 °C
Supply	a.) 6 up to 32 V DC with load-dump protection b.) via USB V = 5 V, IMAX < 500 mA (with Mini-B-USB connector)

Pin assignment

RS1



1	VTRAC
2	GND
3	COM+
4	COM−
5	ISOK
6	ISOL
7	NC
8	RS422 RX+
9	RS422 RX−

RS2



1	NC
2	RS232 RX
3	RS232 TX
4	NC
5	GND
6	NC
7	NC
8	reserved
9	reserved

CAN 1/2



1	CAN2 low
2	CAN2 high
3	NC
4	CAN1 low
5	CAN1 high
6	Ubat
7	CAN GND

CAN 3/4



1	CAN4 low
2	CAN4 high
3	NC
4	CAN3 low
5	CAN3 high
6	Ubat
7	CAN GND

LAN



1	TX+
2	RX+
3	TX−
4	RX−

Order information

V930232000	COMfalcon®
------------	------------



ID-based level measurement – resistance measurement/current measurement

This feature allows to read the CAN level even IO-related and to measure active and passive termination resistors, for example for various diagnostics on a machine. This is especially important if the network may lose data caused for example by short circuits.

The Sontheim Modular Diagnostic Tool Chain

You can easily create your individual and professional diagnostic solution for automation applications with the help of the Sontheim interfaces and diagnostic software. Some use cases by linking hardware and software are:

- CAN data visualization, monitoring and processing
- Parameterization and control of whole CAN networks
- Machine diagnostics
- Flash processes of electronic control units (ECUs)



COMfalcon® plus

COMfalcon® plus is a powerful CAN Interface with WLAN/LAN and optional Bluetooth communication and various equipment options. Use it for monitoring, flashing or analyzing CAN networks and handling layer-7 protocols like CANopen or SAE J1939. Profit also from a Linux operating system and LUA scripting.

Key Features

- CAN
4× independent CAN channels
- WLAN
WLAN interface
- ✶
Bluetooth optional
- RS
232
RS232
- K-Line
K-Line
- ☑
☑
Protocolhandling
- 0101
1010
0101
Optional with data logging, scripting, CAN voltage level oscilloscope functionality
- SD
Optional with integrated SD card
- IP
65
Compact housing with protection class IP65

Interfaces

The COMfalcon® plus has four independent CAN channels and a Freescale PowerPC architecture. WLAN/LAN and optional Bluetooth is used to connect to a diagnostic device. In addition to the CAN interfaces a various of other interfaces such as RS232 or K-Line are available for diagnostic purposes.

Housing and status indicators

The device has a fairly rugged housing built of aluminium with IP65 protection and a easy to use trigger button for logging data. Thanks to the compact design and high shock resistance, COMfalcon® plus can be used in various fields of the automation industry. Two 14-segment displays and nine LEDs are always showing the current status/error code of the device.

LUA Scripting

Own embedded applications are running directly on the COMfalcon® plus in LUA without the need of a third device. Several scripts can be run in parallel. Among other things, it's possible to create and implement own information, such as flash routines, ECU descriptions and more, and thus, for example, access to the CAN or file system. The embedded applications are portable and reusable for future Sontheim VCI generations.

Technical Data

CPU	Freescale PowerPC
RAM	64 MB
Memory	4 GB (up to 32 GB)
CAN interface	4× CAN interface acc. to ISO 11898
Baud rates	50 Kbit/s up to 1 Mbit/s
CAN termination resistance measurement	Terminating resistor of the vehicle CAN network with active bus
CAN Port	2× 7-pole M16 port (like Sontheim CANUSB)
RS232, K-/L-Line interface	M12 5-Pin female connector
LAN	M12 4-pin female connector 10/100 Mbit LAN
WLAN	1× acc. IEEE 802.11b,g,n,d,e,i up to 65 Mbit/s
Bluetooth (optional)	2.1+EDR, Power Class 1.5, BLE 4.0 and ANT
USB	Type mini-B
14-segment display	Boot information, K-line mode, RS-mode, measurement, error codes
LEDs	LAN status LED (green and yellow) WLAN/Bluetooth status LED (green and yellow) 4× CAN status LED (green and yellow) RS232, K-/L-Line status LED (green and yellow)
Dimensions (l×w×h)	110 mm × 150 mm × 35 mm
Housing	Aluminium, protection class IP65
Storage temperature	−40 °C up to +85 °C
Operating temperature	−40 °C up to +60 °C
Supply	via CAN 12 V – 24 V

Pin assignment

CAN 1/2



1	CAN2 low
2	CAN2 high
3	CAN GND
4	CAN1 low
5	CAN1 high
6	Vbat
7	oV

CAN 3/4



1	CAN4 low
2	CAN4 high
3	CAN GND
4	CAN3 low
5	CAN3 high
6	Vbat
7	oV

RS232 / K-/L-Line



1	RS232_RX
2	RS232_TX
3	K_Line
4	L_Line
5	GND

USB



1	VCC
2	USB_D−
3	USB_D+
4	USB_ID
5	GND

LAN (green)



1	ETH_TX+
2	ETH_RX+
3	ETH_TX−
4	ETH_RX−



Error frame detection

This feature allows surveillance and monitoring of a CAN network. The COMfalcon® plus possesses an own logic for detecting error frames and counting them up in a specific internal memory area. That is used for finding intermittent errors like falsified messages of a CAN participant.

ID-based level measurement – resistance measurement/current measurement

This feature allows to read the CAN level even IO-related and to measure active and passive termination resistors, for example for various diagnostics on a machine. This is especially important if the network may lose data caused for example by short circuits.

The Sontheim Modular Diagnostic Tool Chain

You can easily create your individual and professional diagnostic solution for automation applications with the help of the Sontheim interfaces and diagnostic software. Some use cases by linking hardware and software are:

- CAN data visualization, monitoring and processing
- Parameterization and control of whole CAN networks
- Machine diagnostics
- Flash processes of electronic control units (ECUs)

Order information

V930232400	COMfalcon® plus
------------	-----------------



CANfox®

CANfox® is a Sontheim fieldbus-to-USB adapter. Besides its CAN interface it contains a RS232 channel for a maximum of flexibility. The device can be used for monitoring of CAN networks, setting parameters of machines etc.

Key Features

CAN

1× galv. isolated CAN interface acc. to ISO 11898

**RS
232**

1× RS232



Connection via USB 2.0



Free configuration of baud rate including 800 Kbit/s

**32
bit**

Powerful 32-bit microcontroller



CODESYS Gateway-driver available

MT-API

Multi-Thread API for own applications



Driver for Windows 2000 up to Windows 10 with 32- and 64-bit

Housing and interfaces

It is housed in a compact plastic case and offers a CAN channel and a RS232 channel. CAN is implemented via a D-Sub9 connector according to CiA standard. Its USB 2.0 interface enables the CANfox® to be used at any laptop, embedded PC or desktop PC. Once you have installed the driver you will benefit from hot plug and play which is a connection of device to PC without restart. Consequently, CANfox® offers all necessary interfaces located in a tiny case for mobile or stationary use.

More performance, less costs

It is a powerful device within the Sontheim interface group with its 32-bit microcontroller for data-handling. However, the CANfox® is meant to be a flexible and very inexpensive tool. Thus, you can configure the baudrate via software and adapt it to your processes.

Technical Data

CPU	32-bit microcontroller
CAN	1x CAN interface acc. to ISO 11898, via D-Sub9
RS232	1x RS232 interface, via D-Sub9
USB	1x Standard USB Typ A, 75 cm cable length
Baud rates	50 Kbit/s up to 1 Mbit/s, free configuration
Max. Data transfer	1 Mbit/s at 90% Bus load
LEDs	3x 3 mm LED
Housing	compact plastic
Operating temperature	-20 °C up to +60 °C
Storage temperature	-40 °C up to +85 °C
Rel. Humidity	20% – 90% non-condensing
Power supply	via USB interface
CANAPI (=Windows DLL)	Windows 2000, XP, Vista, 7, 8; 32-bit. Windows 98 on request

Pin assignment

USB



1	VCC (VBUS)
2	- Data
3	+ Data
4	GND

CAN



2	CAN low
3	CAN Ground
7	CAN high

RS232



2	TXD
3	RXD
5	GND

Comprehensive software support

Of course, CANfox® is supported by all Sontheim tools like CANexplorer 4 for CAN bus diagnostics or MDT® for machine applications like diagnostics or End-of-Line processes. With the help of the included software interface (API), users can also run their own software. There is also a CODESYS support implemented in order to use the device for PLC and motion control tasks. Use it as a programming gateway for CODESYS-based PLCs or for downloading programmes directly out of a CODESYS programming environment.

The Sontheim Modular Diagnostic Tool Chain

You can easily create your individual and professional diagnostic solution for automation applications with the help of the Sontheim interfaces and diagnostic software. Some use cases by linking hardware and software are:

- CAN data visualization, monitoring and processing
- Parameterization and control of whole CAN networks
- Machine diagnostics
- Flash processes of electronic control units (ECUs)



MDT®



CANfox®



Automation application

Order information

V930322000

CANfox®



CANUSB

This is a top seller among the Sontheim interface family. It facilitates a quick and sturdy connection between PC or notebook and CAN bus. CANUSB is highly flexible, user-friendly and market-proven. Thousands of units are already in the field, used for monitoring of CAN networks, setting parameters of machines etc.

Key Features



Shock-resistant aluminium extrusion housing



1 or 2 galv. isolated CAN channels with 1 Mbit/s transfer capacity at 90 % bus load



Hot plug and play ensures fast and convenient commissioning



MT-API enables access to CAN bus for own applications



Optional variant with error frame detection



Ideal for use with a PC or notebook

Housing

The device has a fairly rugged housing built of aluminium. Its compact design and resistivity against shock make it very popular in many areas of the automation industry.

CAN channels

There are either 1 or 2 galvanically isolated CAN channels available which comply with ISO 11898-2. The transfer rate ranges up to 1 Mbit/s at 90 % bus load.

Flexible data processing

Its USB 2.0 interface enables the CANUSB to be used at any laptop, embedded PC or desktop PC. Once you have installed the driver you will benefit from hot plug and play which is a connection of device to PC without restart.

Microcontroller and firmware update

The Motorola STAR12 and the Philips PDIUSB12 guarantee a quick data processing. Both CAN 2.0 A and CAN 2.0 B are supported. CANUSB is suited for numerous operating systems like Windows XP, XP embedded, Vista and 7. All firmware updates can be loaded via USB.

Technical Data

CPU CAN	Motorola Star12, 16-bit
CPU USB	Philips PDIUSB12
CAN	1x CAN interface acc. to ISO 11898-2, galv. isolated (optional 2x CAN)
USB	1x USB 2.0
CAN connection	1x 7-pin round plug
USB connection	1x standard USB connector type A
Cable CAN	optional 2 m CANUSB cable
Cable USB	1 m Standard USB
Max. data transfer	1 Mbit/s at 90 % bus load
Error frame detection	optional
Analog level measurement	integrated
LEDs	2x triple 3 mm LED angled
Dimensions (l×w×h)	100 mm × 57 mm × 32 mm
Weight	166 g
Housing	Solid aluminium
Operating temperature	0°C up to +70°C
Storage temperature	-20°C up to +85°C
Rel. Humidity	20 % - 90 % non-condensing
Power consumption	max. 350 mA at 5 V
Power supply	via USB interface

Pin assignment

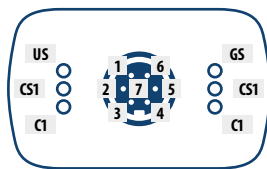

CAN

US	USB Status
CS1	CAN Status 1
C1	CAN 1 receive / transmit action
GS	Device status
CS2	CAN Status 2
C2	CAN 2 receive / transmit action
1	CAN2 low
2	CAN2 high
3	-
4	CAN1 low
5	CAN1 high
6	-
7	CAN GND

USB

1	VCC (VBUS)
2	- Data
3	+ Data
4	GND

Order information

V930204000	CANUSB, 2x CAN, Errorframe, level measurement
V930205000	CANUSB, 2x CAN, Errorframe
V930206000	CANUSB, 2x CAN
V930207000	CANUSB, 1x CAN, Errorframe, level measurement
V930208000	CANUSB, 1x CAN, Errorframe
V930209000	CANUSB, 1x CAN
V930220000	CANUSB-cable, 2 m, 120 Ohm
V930220100	CANUSB-cable, 2 m, (2x D-Sub9 male)

Error frame detection

This feature allows surveillance and monitoring of a CAN network. The CANUSB possesses an own logic for detecting error frames and counting them up in a specific internal memory area. That is used for finding intermittent errors like falsified messages of a CAN participant.

Level measurement

This feature is designed for an analog measurement of CAN levels. It is used for doing diagnostics at vehicles of all kinds or machines. It is especially important when data is lost from the network, which can be caused by short circuits, for example.

Programming interface

The CANapi provides all functions for programming own applications. It supports all Sontheim interfaces and several third-party devices which is why we enclose our SiECA132 MT-CANapi with four simultaneous handles at every interface dongle.

The Sontheim Modular Diagnostic Tool Chain

You can easily create your individual and professional diagnostic solution for automation applications with the help of the Sontheim interfaces and diagnostic software. Some use cases by linking hardware and software are:

- CAN data visualization, monitoring and processing
- Parameterization and control of whole CAN networks
- Machine diagnostics
- Flash processes of electronic control units (ECUs)

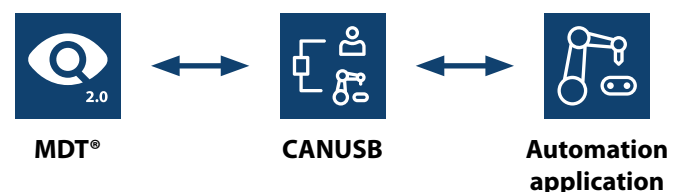



PowerCAN-PCI

PowerCAN-PCI V2 is a highly advanced and ultra-fast CAN controller card for the connection of PCs with PCI-slot to the CAN bus. It is able to handle the full control, regulation and parametrisation of small to complex CAN networks.

Key Features



PC assumes the function of a CANopen manager



Control of other CANopen devices, e.g. motor controls



Transmission performance of 1 Mbit/s at 90% bus load



Freescale Coldfire with 32 MHz clock frequency



2× galvanically isolated CAN channels



Equipment with high or low speed interface



LEDs for bus status display on the front bracket

Compatibility

The device is a PCI-card with two galvanically isolated CAN interfaces according to ISO 11898. Being fully compatible to PCI-specification 2.2, it can be used with any PC-system that has an unoccupied PCI-slot. Both active CAN controllers offer 15 message objects each and comply with FullCAN.

CPU

The Coldfire from Freescale is used as a powerful micro-controller. The controller is operated in 16-bit demultiplexed mode, which guarantees an optimal connection to the PCI controller. The implemented bootstrap loader makes it easy to load the firmware. Two “on-chip” CAN controllers realize the CAN connection in 2.0 B active mode.

Memory

Even complex fieldbus-controlling tasks can easily be handled with 8 MB RAM and 2 MB flash memory. There is no need for an external programming power supply, the flash memory is supplied with 5 V for writing and deleting. The flash also contains the firmware which can be updated via bootstrap-loader.

Technical Data

CPU	Freescale Coldfire
RAM	8 MB
Memory	2 MB
CAN	2× CAN interface acc. to ISO 11898, galv. isolated
CAN controller	2× FullCAN according to CiA (DIN41652)
CAN transceiver	Philips 82C251
CAN protocol	2.0 A and 2.0 B
CAN connectors	2× D-Sub9
Bus system	PCI
PCI controller	acc. to PCI 2.2 specification 16k Dual-Port-RAM
LED	4× LED (green)
Dimensions (l×w×h)	164 mm × 102 mm × 13 mm
Operating temperature	0°C up to +60°C
Storage temperature	-20°C up to +75°C
Rel. Humidity	20 % – 90 % non-condensing
Power supply	5 V
Power consumption	500 mA
CANopen driver	for Windows NT
Layer 2 driver	for Windows 98, ME, NT, 2000, XP, Vista, 7; 32- and 64-bit

CAN interface

Two galvanically isolated CAN channels with a transfer rate of up to 1 Mbit/s provide the necessary controlling power. In addition to that there are two active 2.0 B CAN controller implemented that allow a mixed mode with 11-Bit and 29-Bit identifiers. The CAN interface complies with ISO 11898 standard as well as DS 301 and 401.

Error frame detection

This feature allows surveillance and monitoring of a CAN network. The PowerCAN card possesses an own logic for detecting error frames and counting them up in a specific internal memory area. That is used for finding intermittent errors like falsified messages of a CAN participant.

Blockschaltbild

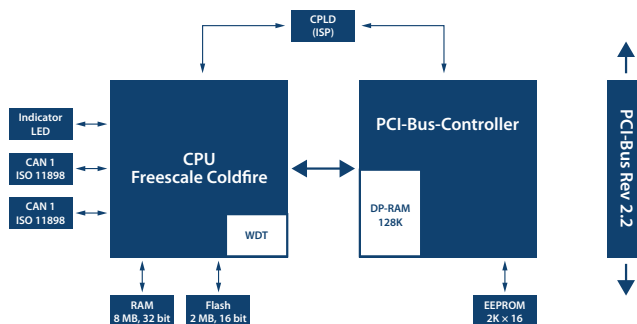

Pin assignment



CAN

2	CAN low
3	CAN Ground
7	CAN high

Order information

V930154000	PowerCAN-PC
------------	-------------



CIN

CIN is a board variant of the Sontheim CAN adapters with numerous interfaces for communication. Its extended temperature range and a number of diagnostic functions make it a perfect embedded module for industrial signal applications.

Key Features

32
bit

Freescale microcontroller



Wide range of interfaces



Can be used as a board solution or as a communication centre in the Diag-Box



Internal flash and RAM memory



Also suitable for harsh environments due to increased temperature range



Extensive software support

Interfaces

There are four CAN interfaces next to two single-wire CAN, eight digital inputs and eight digital outputs. Moreover, CIN uses ethernet and I²C for controlling peripheral components. It is possible to have it assembled either as a piggyback board onto another PCB or in the Diag-Box as a high-performance communication node. The ethernet channel is also used for building up a gateway function for CAN-to-Ethernet.

Error frame detection

Similar to a CANUSB, CIN is equipped with error frame detection. This feature allows surveillance and monitoring of a CAN network. It has an own logic for detecting error frames and counting them up in a specific internal memory area. That is used for finding intermittent errors like falsified messages of a CAN participant.

Level measurement

This feature is designed for an analog measurement of CAN levels. It is used for doing diagnostics at vehicles of all kinds or machines. Erratic level indicate for example short circuits. They are often responsible for data loss.

Technical Data

CPU	Freescle MPC 512x
RAM	32 MB, optionally 64 and 128 MB available
Memory	16 MB
Ethernet/PHY	10/100 Mbit/s
CAN interfaces	4× CAN transceivers, first transceiver with wake-on-CAN function Bus termination: 120 Ω, optionally mounted on circuit board Diagnostics: ErrorFrame detection on separate FPGA for all channels Diagnostics: Analog level measurement with simultaneous measurement of CAN high and CAN low CAN channels are not galvanically isolated
Digital input	8×, power supply 3.3 V
Digital output	8×, power supply 3.3 V, 10 mA
Single wire CAN	2×
I ² C	1×
Assembly	Customized circuit board solution or Diag-Box
Software support	CANexplorer 4, MDT®, ODX-Editor, SiECA132 MT-API and others on request
Operating temperature	−20 °C up to +85 °C
Storage temperature	−40 °C up to +85 °C
Power supply	+UBat (12 V or 24 V), +3.3 V, 5 V
More	Can also be used as CAN-to-Ethernet bridge/gateway

Order information

V930230120

CIN MPC5123 Error frame, level measurement



IoT Device Manager

Cloud-based platform for managing your devices in the field.

Key Features



Management of all telematics units



Drag and drop functionality



Managing updates over-the-air



Simple configuration of all devices



Fast data consumption analysis



Live data monitoring

The IoT Device Manager is a cloud-based tool for the simple and clear management of your telematics units in the field. You can group and structure your devices by drag and drop and manage software packages for wireless over-the-air updates.

Collect live data during vehicle operation or flash software wirelessly:

- Mobile networks (2G/LTE)
- WLAN

Store telemetry data for further analysis and support the following functions:

- QA Statistics
- Usage statistics
- Planning of service intervals
- vehicle lifecycle support

Store telemetry data and check information such as:

- SIM card number (IMSI)
- Serial number of the LTE device
- Last connection to the server
- Signal Quality
- Network Bandwidth
- Device configuration

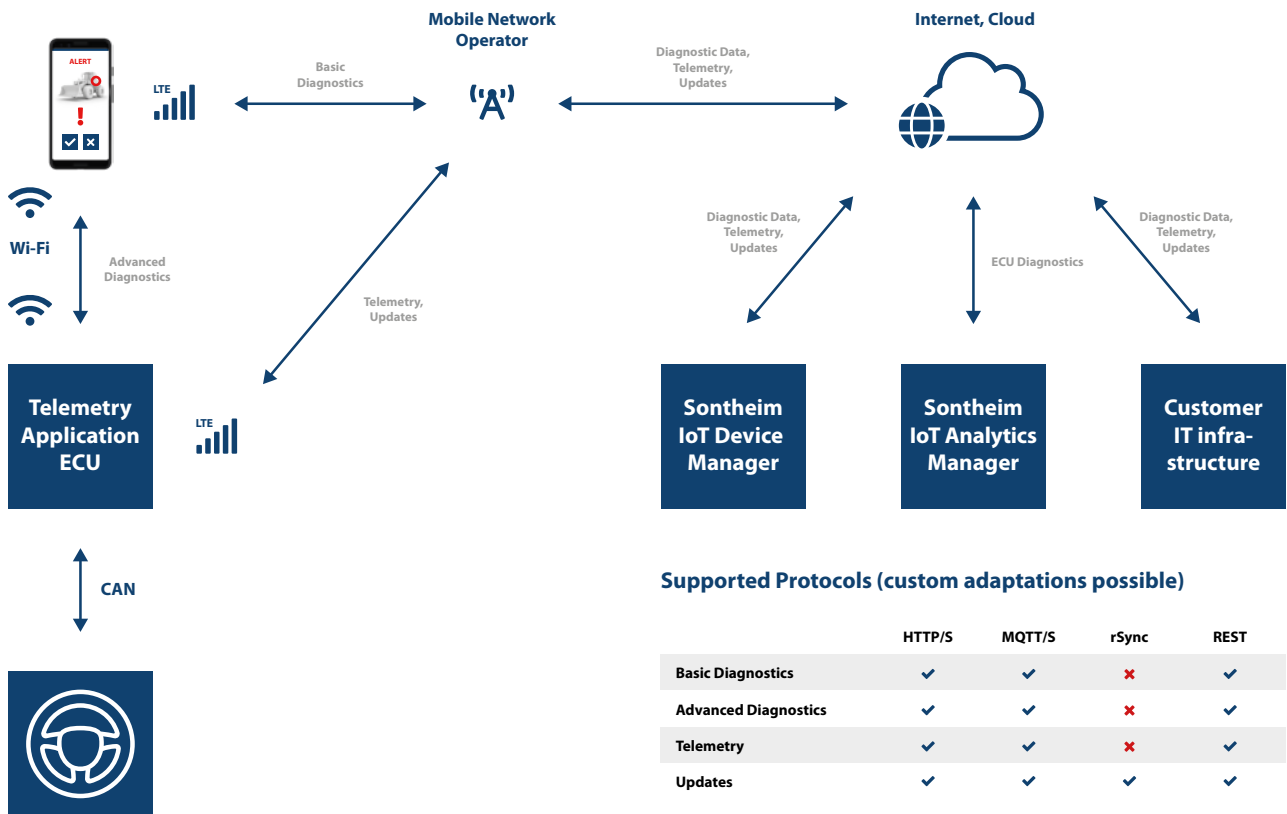

Supported Protocols (custom adaptations possible)

	HTTP/S	MQTT/S	rSync	REST
Basic Diagnostics	✓	✓	✗	✓
Advanced Diagnostics	✓	✓	✗	✓
Telemetry	✓	✓	✗	✓
Updates	✓	✓	✓	✓

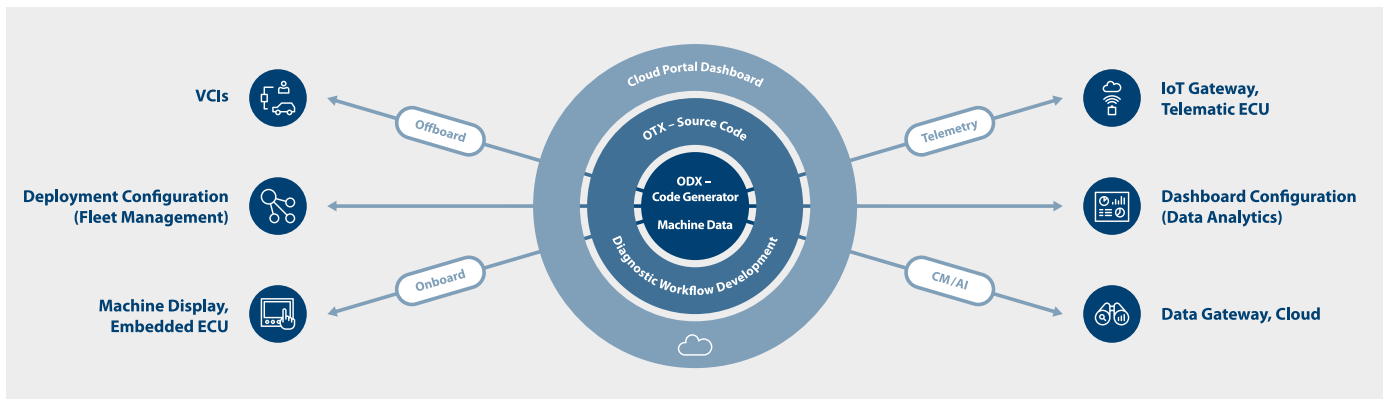

The IoT Device Manager can be hosted on a server on the Sonheim side or seamlessly integrated into an existing customer infrastructure. Secure data transfer is ensured thanks to SSL/TLS certification and can even be extended according to individual customer requirements. The IoT Device Manager can be branded OEM-specific. This allows the user to create different user levels, for viewing with different rights or for easy integration of sub supplier views.

Order information

V940871100	IoT Device Manager
------------	--------------------



Do you have Questions?

Please feel free to contact us. If you have any questions, suggestions or requests regarding our products and the company, we will be happy to help you.

You can reach us at info@s-i-e.de





Mobile Automation



Industrial Automation



Diagnostics



Connectivity

We are looking forward to your enquiry!

Sontheim Industrie Elektronik GmbH

Georg-Krug-Straße 2
D-87437 Kempten
Phone: +49 (0)831 575900-0
Fax: +49 (0)831 575900-72
Email: info@s-i-e.de

Sontheim Electronic Systems L.P.

201 West 2nd Street
Davenport, IA 52801, USA
Phone: +1 563 888 1471
Email: info@sontheim-esys.com

www.s-i-e.de